

COMICA
PROFESSIONAL AUDIO EQUIPMENT

SIG.LAV V03

Multi-functional Single Lavalier Microphone
(Universal for Camera&Phone)



USER MANUAL

Foreword

Thanks for purchasing the Comica SIG.LAV V03 lavalier microphone

The product is mainly designed for camera, cellphone. It's a lavalier microphone with built-in preamplifier and audio monitor.

To ensure a good using experience and your safety, please carefully read this instruction before using and properly assemble and operate.

Notice

- ⚠ When used with smartphone, please purchase separate audio cable adapter with corresponding interface;
- ⚠ For the Android system smartphone, the microphone works well in audio mode, but video mode will happen with incompatibility trouble while working with some smartphone;
(Then we suggest you try the 3rd party's video APP);
For the iOS system phone, the microphone works well in all audio mode, video mode, and 3rd party's APP;
- ⚠ In working state, the light indicator will keep green light on to help you check the working status of the product at any time;
- ⚠ The product belongs to the super accurate instrument, please pay attention to avoid any dropping, collision or thump;
- ⚠ Please do not put the device beside the heat or interference source, like radiator, Roaster or air-condition, etc;
- ⚠ Please keep this product in the dry environment;
- ⚠ Do not expose the device in rain or humid environment, otherwise there will be a danger of short circuit;

Main Features

- . Omni-directional Microphone
- . Universal for Camera&Smartphone
- . Real-time Monitor
- . Super Anti-interference
- . CR2032 Battery Design, Simple Operation



Omn-directional



Camera&Smartphone



Real-time Monitor



Super Anti-interference



Simple Operation

Package List



Microphone



Winding Plate



Wind Muff



Carrying Case



User Manual



Warranty Card

Components Instruction

- ① 3.5mm TRRS Plug
- ② Power/Camera/Smartphone Switch
- ③ Lavalier Microphone
- ④ 3.5mm Monitor Jack
- ⑤ Battery Tray Control Gear
- ⑥ Belt Clip
- ⑦ Battery Tray

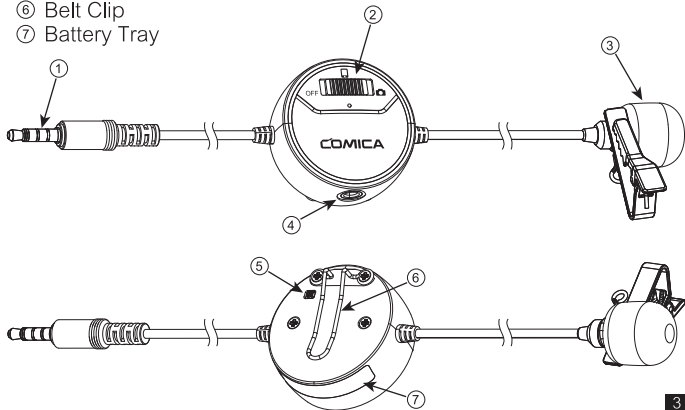

Operation Instruction

1. Power the Microphone

Remove the insulator before use

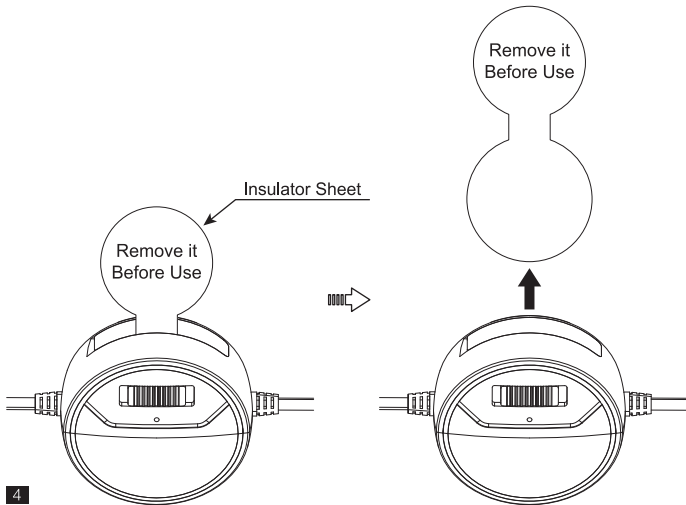

2. Replace the Battery

Put the battery tray out as the followed illustration first, then replace old battery with new one (Note: please follow the instructions and pay attention to the direction of the positive and negative electrode), then push back battery tray to microphone body; battery is replaced

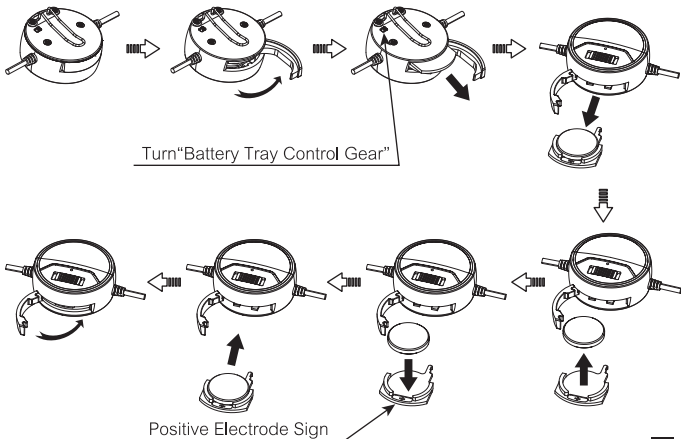

3. Microphone Installation&Use

Insert 3.5mm TRRS plug into 3.5mm audio input port of camera/smartphone, in the meantime put the button "Power/Smartphone/Camera Switch" to the corresponding mode;

Plug the 3.5mm monitor cable into the monitor jack for real-time monitoring;
Record after placing the lavalier microphone at the sound source and keeping it at the right distance

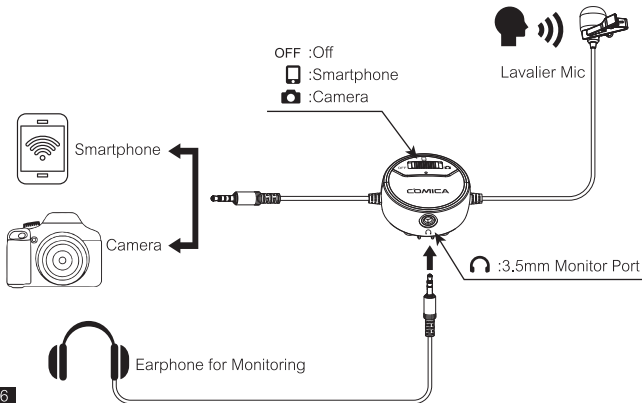

Technology Parameters

1. Frequency Response

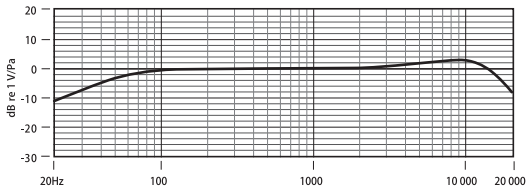

2. Polar Pattern

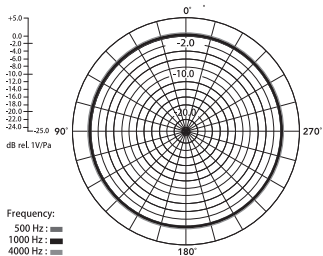

3.Technology Parameters

Polar Pattern	Omni-directional
Sensitivity	-23±3dB
Frequency Response	60Hz~18kHz
Signal/Noise	>60dB
Max SPL	>100dB
Output	3.5mm Output Plug
Monitor Jack	3.5mm Monitor Jack
Battery	CR2032 3V
Length	6.2m
Working Temperature	0°C~50°C



Website: comica-audio.com

Facebook: Comica Audio Tech Global

Instagram: Comica Audio

YouTube: Comica Audio

COMICA is a registered trademark owned by Commlite Tech Co.,Ltd

Email: support@comica-audio.com

COMICA
PROFESSIONAL AUDIO EQUIPMENT

SIG.LAV V03

多功能单领夹式麦克风
(相机手机通用)



用户使用手册

前 言

感谢您购买COMICA/科唛 SIG. LAV V03领夹麦克风；

本产品专为相机、手机设计而成，是一款内置前置放大器并带监听输出的领夹式麦克风；

为保证产品的顺畅使用，请在使用前严格阅读本说明书，并正确组装及操作。

注意事项

- ⚠ 当配合手机使用时请另外购买相关音频输入接口转换线；
- ⚠ 配合Android（安卓）系统的手机使用时，录音模式下均可正常工作，视频模式下部分手机会出现不兼容情况（此时建议使用第三方视频软件，如：抖音，快手等）；
配合iOS系统手机使用时，在所有录音模式、视频模式以及第三方视频软件下均可正常使用；
- ⚠ 工作状态下，指示灯将一直保持绿色常亮状态，协助您随时查看产品工作状态；
- ⚠ 本产品属于高精密仪器类产品，请避免使用时掉落、碰撞或重击；
- ⚠ 请勿将本设备放置在热源或干扰源附近使用，如散热器、烤箱或冰箱空调旁边；
- ⚠ 请在干燥环境中对该产品进行保存；
- ⚠ 不要在雨中或潮湿的环境中使用该设备，否则会有短路的危险；

产品主要功能

- 全指向拾音
- 手机相机通用
- 实时监听
- 超强抗干扰
- CR2032电池供电设计，简易操作



全指向拾音



相机手机通用



实时监听



超强抗干扰



简易操作

包装清单



麦克风主体



绕线板



防风毛



便携袋



说明书



保修卡

部件介绍

- ① 3.5mm TRRS插头
- ② 开关/手机/相机切换
- ③ 领夹麦克风
- ④ 3.5mm监听插孔
- ⑤ 电池仓控制开关
- ⑥ 背夹
- ⑦ 电池仓

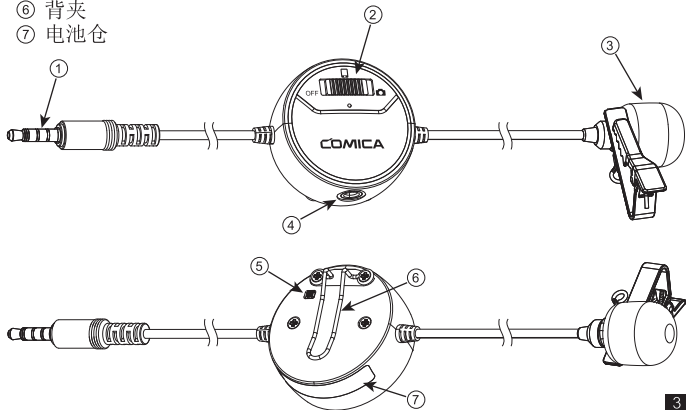

操作说明

1. 机器通电

使用前请把电池绝缘片取出来

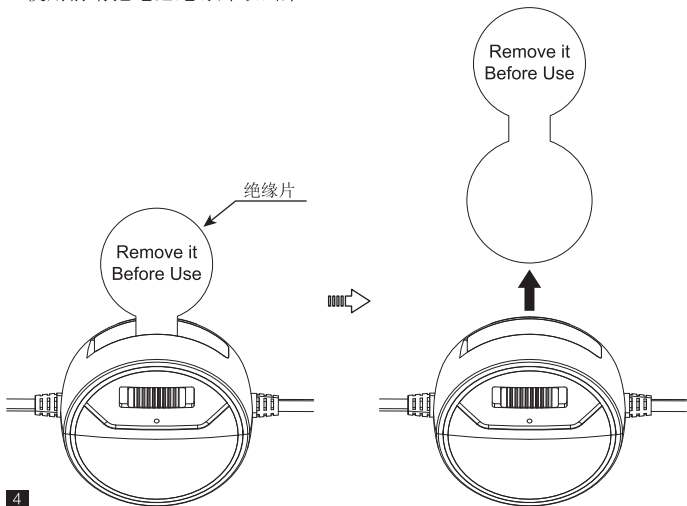

2. 电池更换

将电池托盘按图示方向取出，取出旧电池，再放入新电池（注：请按托盘的提示注意正负极的方向），再推回麦克风主体，电池更换完毕

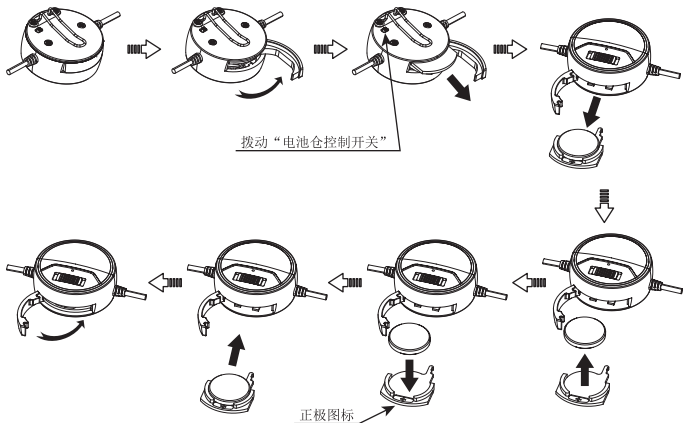

3. 安装使用方式

将3.5mm TRRS插头插入手机或相机3.5mm音频输入插孔，相应的把“开关/手机/相机切换”按钮切换到对应的模式；
将监听耳机的3.5mm插头插入监听孔即可实时监听；
将领夹麦克风对准音源并保持合适的距离即可录音

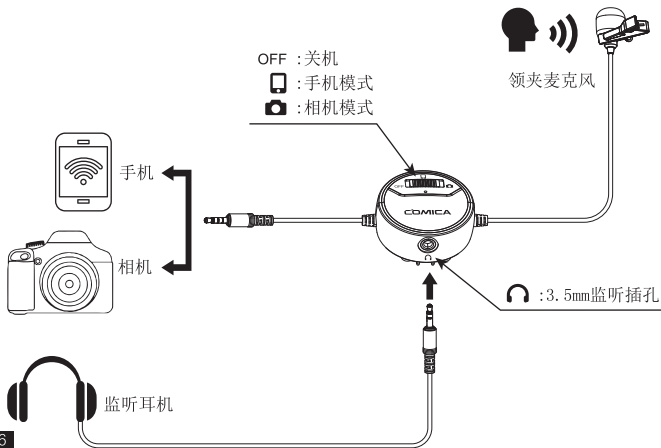

规格参数

1. 频率响应

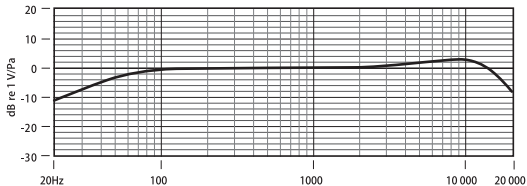

2. 指向性图

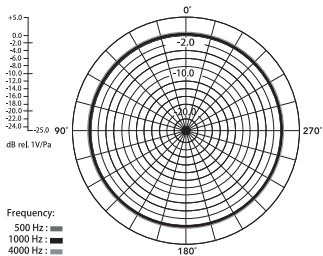

3. 性能参数

指向性	全指向
灵敏度	$-23 \pm 3\text{dB}$
频率响应	60Hz~18kHz
信噪比	$>60\text{dB}$
最大声压级	$>100\text{dB}$
输出	3.5mm 插头
监听插孔	3.5mm 插孔
电池	CR2032 3V
长度	6.2m
工作温度	$0^{\circ}\text{C} \sim 50^{\circ}\text{C}$



扫二维码关注
科唛官方公众号



COMICA科唛



COMICA科唛



COMICA科唛



COMICA科唛

邮箱: support@comica-audio.com

电话: 400-8303-981

网址: comica-audio.com

版权及科唛商标归咪莱科技有限公司所有