

COMICA
PROFESSIONAL AUDIO EQUIPMENT

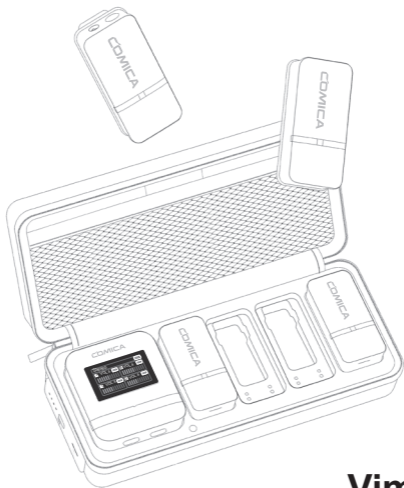

Vimo Q

Four-channel Mini Wireless Microphone

User Manual

Foreword

Thank you for purchasing Comica Vimo Q Wireless Microphone

Main Features

- Four-channel Wireless Microphone, Mini and Portable
- 48kHz/24bit Record, CD-level Sound Quality
- Brand-new CalMix Audio Processing, One-key Denoise
- Support 4 Audio Tracks Mixing and Individual Output
- Digital/Analog Outputs, Universal for Camera/Smartphone/PC
- Support Real-time Monitoring, Mute, Volume Control, M/S Switch
- HD Screen Display, Support Screen Flip
- Internal and External MIC Two Input Modes
- USB-C Charging Port, Support Charging While Using
- Charging&Storing Case, Duration Up to 16H
- Low Latency<20ms, Working Range Up to 200M

Notice

- △ It is better to keep face to face when using it and not turn your back to the receiver. Otherwise, it is easy to generate breakpoints, which is a normal phenomenon
- △ Please notice that the STEREO function can not be realized when recording in single-channel
- △ Quad mode is not supported when outputting audio through USB interface
- △ There will be a "ticking" sound when switching on/off the quad mode. It is recommended to select the corresponding mode before recording
- △ The product is a high-precision equipment, please prevent it from falling, collision, or pounding
- △ Do not use this device near sources of heat or interference, such as radiators, ovens, refrigerators, air conditioners, etc
- △ If the sound pickup distance is close or record outdoors, please put the wind muff on the transmitter to prevent sound bursting or reduce wind noise
- △ Please keep the product in a dry environment; do not use the equipment in rainy or damp environments to avoid short-circuit danger

Packing List

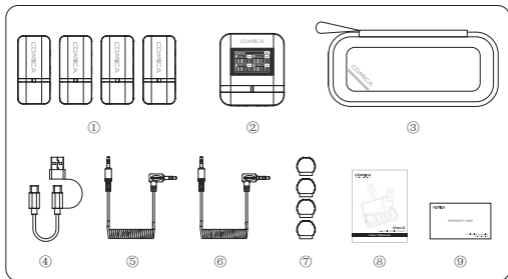

1. Transmitter*4
2. Receiver
3. Charging Case
4. 2-in-1 Charging/Audio Output Cable
5. 3.5mm TRS-TRS Audio Cable
6. 3.5mm TRS-TRRS Audio Cable
7. Wind Muff*4
8. User Manual
9. Warranty Card

Components and Instruction

Transmitter (TX)

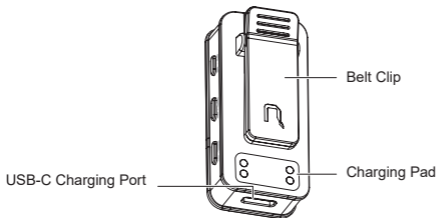
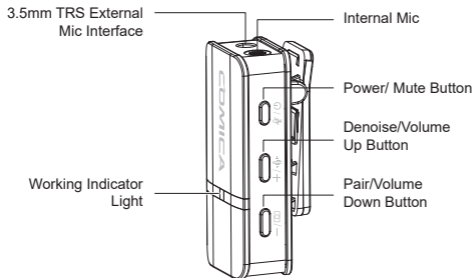

1. 3.5mm TRS External Mic Interface

2. Internal Mic

3. Power/ Mute Button

Long press for On/Off; short press for muting switch

4. Denoise/Volume Up Button

Long press to turn on/off denoise; shot press to increase the volume

5. Pair/Volume Down Button

Long press to enter pairing state; short press to decrease the volume

6. Working Indicator Light

Red light on when muting; green light on when denoising, blue light on in original sound

7. USB-C Charging Port

To connect a power bank/DC power supply through the 2-in-1 charging/audio output cable for charging

8. Belt Clip

9. Charging Pad

Receiver (RX)

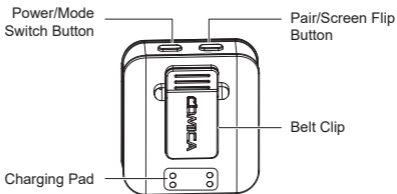
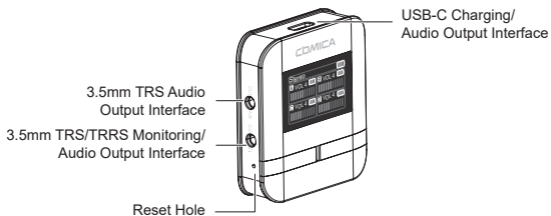

1. 3.5mm TRS Audio Output Interface

In mono mode, output a mixing audio of A/B/C/D four channels;

In stereo mode, output two individual audios. A/C channel is the left channel, B/D channel is the right channel;

In quad mode, output two individual audios of A/B channels

2. 3.5mm TRS/TRRS Monitoring/Audio Output Interface

In mono/stereo mode, plug in 3.5mm TRS/TRRS headphones to monitor;

In quad mode, output two individual audios of C/D channels

3. Reset Hole

If there are abnormal phenomena such as crashes or failure to turn on, insert a pin into the reset hole to reset and restart automatically

4. USB-C Charging/Audio Output Interface

To connect the power bank/DC power supply for charging or connect mobile phone/computer for digital audio output through the 2-in-1 charging/audio output cable

5. Power/Mode Switch Button

Long press for On/Off; short press to switch mono/stereo modes

6. Pair/Screen Flip Button

Long Press to enter pairing state; short press to flip the screen

7. Charging Pad

8. Belt Clip

Screen Display :

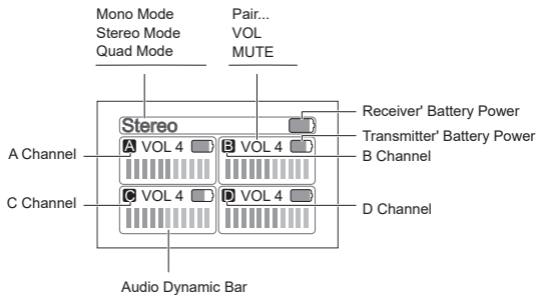

Charging Case :

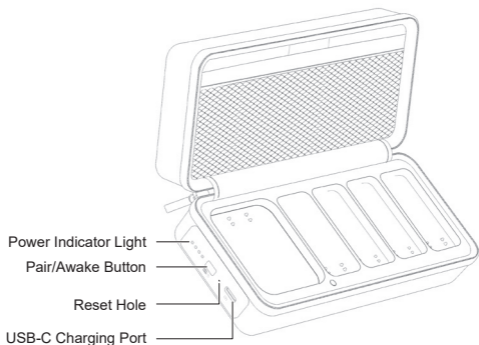

1. Power Indicator Light

There are four lights, each representing 25% of the power

2. Pair/Awake Button

Long press to pair the microphone; short press to awake the microphone

3. Reset Hole

If the device cannot be charged, insert a pin into the reset hole to reset it

4. USB-C Charging Port

To connect a power bank/DC power supply through the 2-in-1 charging/audio output cable for charging

Installation and Usage

Pairing Method (All have been paired by default. If you need to re-pair, please follow the instructions)

Place the transmitters and receiver within one meter and long press their power buttons to switch on, then long press their pair buttons to enter the pairing state. During the pairing state, the indicator lights of transmitters alternately flash red, blue, and green, and the receiver screen shows "Pair...". After successful pairing, the indicator lights of the transmitters turn blue, and the receiver screen displays the status of the connected channels.

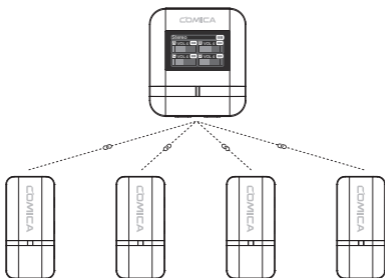

If any transmitter is not paired, please turn off all transmitters and receiver, and then follow the above steps to pair again.

Installation

Transmitter (TX) :

To choose internal mic or external mic according to personal needs

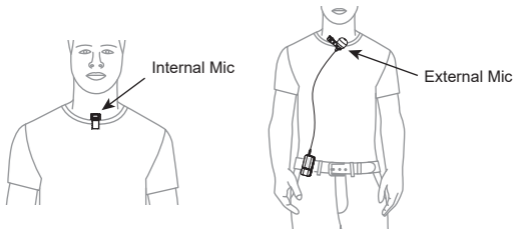

1. When using the internal mic, it is recommended to fix the belt clip outwards for better concealment
2. When using an external mic, the internal mic will automatically turn off

Receiver (RX) :

Mono/Stereo Mode

1. 3.5mm Analog Output

When used with a camera, connect it through the 3.5mm TRS-TRS audio cable; When used with a mobile phone or computer, connect it through the 3.5mm TRS-TRRS audio cable and related OTG audio cable/adaptor; to monitor according to personal needs (please purchase the relevant audio cable/adaptor by yourself)

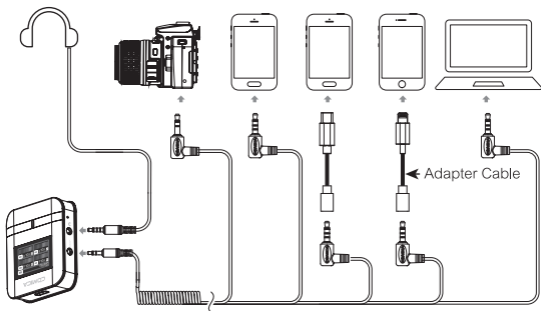

In stereo mode, A/C channel is the left channel, B/D channel is the right channel

2. USB Digital Output

Connect the receiver and mobile phone/computer through the 2-in-1 charging/ audio output cable and related OTG audio cables/adapters; to monitor according to personal needs (please purchase the relevant audio cable/adapter by yourself)

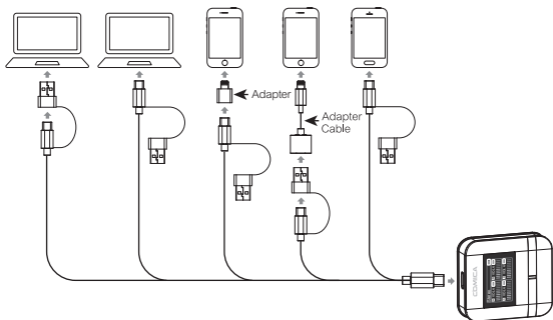

Quad Mode

Connect the receiver and recorder/mixer through a 3.5mm TRS-TRS/ 3.5mm TRS-XLR dual heads audio cable to output four individual analog audios of A/B/C/D channels(Please purchase relevant audio cables by yourself)

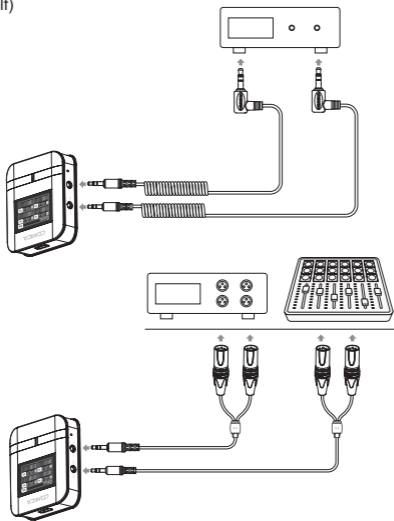

Quad mode is not supported when outputting audio through USB interface

Specification

Antenna	Ceramic Antenna
Transmitting Power	10dBm
Receiving Sensitivity	-97dBm
Microphone Sensitivity	-32dB±2dB
Polar Pattern	Omnidirectional
Frequency Response	80Hz ~ 20kHz
S/N	70dB SPL(A-weighted,as per IEC651)
Equivalent Noise	24dB SPL(A-weighted,as per IEC651)
Maximum SPL	110dB SPL(@ 1% THD)
Dynamic Range	86dB SPL(A-weighted,as per IEC651)
Sound Delay	<20ms
USB Specification	48kHz/24bit
Battery	TX: Li-polymer 140mAh 3.7V RX: Li-polymer 600mAh 3.7V Charging Case: Li-polymer 2900mAh 3.7V
Charging Time	TX: 3 Hours RX: 3 Hours Charging Case:3 Hours
Battery Life	TX: 8 Hours RX: 8 Hours Charging Case:1 Time
Net Weight	TX: 16g RX: 37g Charging Case: 330g
Dimension	TX: 51 x 24 x21mm RX: 54 x 48 x 22mm Charging Case: 186 x 93 x 63mm
Working Temperature	0°C ~ 50°C
Storage Temperature	-20°C ~ 60°C



Website: comica-audio.com

Facebook: Comica Audio Tech Global

Instagram: Comica Audio

YouTube: Comica Audio

COMICA is a registered trademark owned by Commlite Tech Co.,Ltd

Email: support@comica-audio.com

COMICA 科
PROFESSIONAL AUDIO EQUIPMENT 唛



Vimo Q

四通道迷你无线麦克风

使用说明书

前言

感谢您购买科唛Vimo Q无线麦克风

主要功能

- 四通道无线麦克风，迷你便携
- 48kHz/24bit录音，超CD级音质
- 全新CalMix音频处理技术，一键降噪
- 支持四路音频声道并轨/分轨输出
- 数字&模拟双输出，通用于相机/手机/电脑
- 实时监听、一键静音、音量调节、M/S切换
- 高清屏显监控，支持一键翻转
- 内置和外置MIC两种输入方式
- USB-C充电接口，支持边充边用
- 多功能充电收纳盒，总续航高达16小时
- 低频延迟<20ms，传输距离高达200米

注意事项

- △ 使用时尽量保持面对面，避免背对的情况，否则容易产生断点，属正常现象
- △ 单通道模式下，立体声(STEREO)功能不可实现
- △ 通过USB输出时，不支持分轨模式
- △ 开启或关闭分轨模式时有“滴答”声，建议先选择对应模式再开始录制
- △ 本产品属于高精密仪器类产品，请避免使用时掉落、碰撞或重击
- △ 请勿将本设备放置在热源或干扰源附近使用，如散热器、烤箱、冰箱、空调等
- △ 如拾音距离较近或于户外使用时，请套上麦克风防风毛，防止声音爆裂或降低风噪
- △ 请在干燥环境中对该产品进行保存，不要在雨中或潮湿的环境中使用该设备，否则会有短路的危险

包装清单

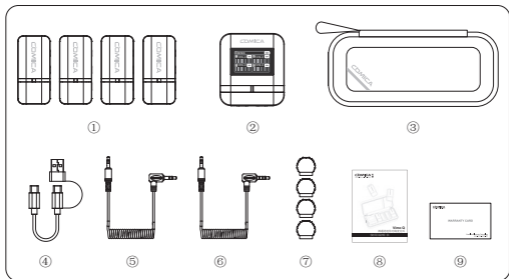

1. 发射器(TX)*4
2. 接收器(RX)
3. 充电盒
4. 二合一充电/输出连接线
5. 3.5mm TRS-TRS音频连接线
6. 3.5mm TRS-TRRS音频连接线
7. 防风毛*4
8. 说明书
9. 保修卡

部件介绍及说明

发射器(TX)：

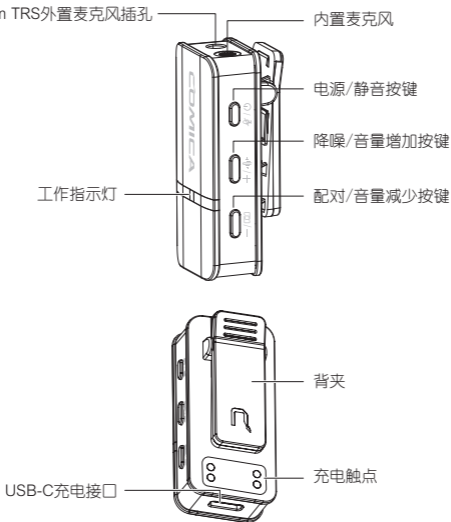

1. 3.5mm TRS外置麦克风插孔

2. 内置麦克风

3. 电源/静音按键

长按开/关机，短按开启/关闭静音

4. 降噪/音量增加按键

长按开启/关闭降噪，短按加大音量

5. 配对/音量减少按键

长按进入配对状态，短按减少音量

6. 工作指示灯

静音时亮红灯，降噪时亮绿灯，原声时亮蓝灯

7. USB-C充电接口

通过二合一充电线连接充电宝/DC电源进行充电

8. 背夹

9. 充电触点

接收器(RX)：

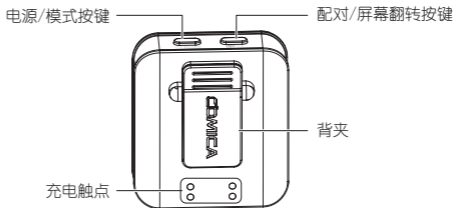
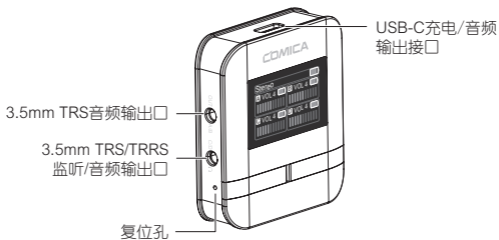

1. 3.5mm TRS音频输出口

单声道模式下，输出A/B/C/D四路通道合并音频；

立体声模式下，输出两路独立音频，A/C通道为左声道，B/D通道为右声道；

分轨模式下，输出A/B通道两路独立音频

2. 3.5mm TRS/TRRS监听/音频输出口

单声道/立体声模式下，插入3.5mm TRS/TRRS耳机即可监听；

分轨模式下，输出C/D通道两路独立音频

3. 复位孔

如出现死机或开不了机等异常现象，使用卡针插入复位孔即可复位并自动重启

4. USB-C充电/音频输出接口

通过二合一充电/音频输出线连接充电宝/DC电源进行充电，或连接设备输出数字音频

5. 电源/模式按键

长按开/关机，短按切换单声道/立体声/分轨模式

6. 配对/屏幕翻转按键

长按进入配对状态，短按翻转屏幕

7. 充电触点

8. 背夹

屏幕显示:

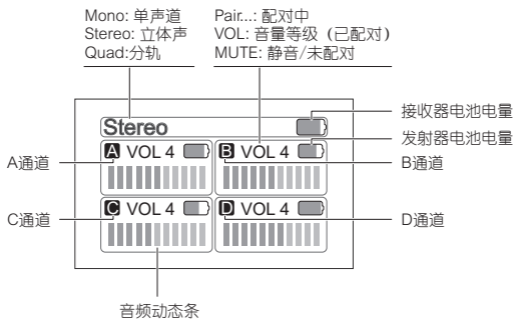

充电盒：

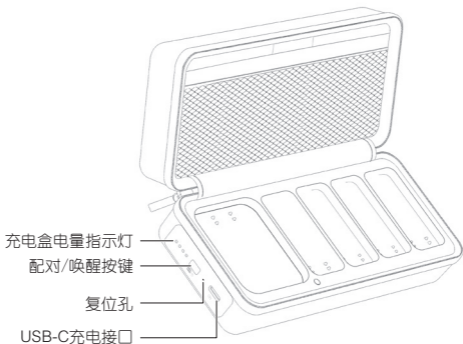

1. 充电盒电量指示灯

共有四颗指示灯，每颗代表25%电量

2. 配对/唤醒按键

长按麦克风配对，短按唤醒麦克风

3. 复位孔

如出现无法充电等异常现象，使用卡针插入复位孔即可复位

4. USB-C充电接口

通过二合一充电线连接充电宝/DC电源进行充电

■ 安装与使用

配对(出厂已默认配对,如遇特殊情况需重新配对可参考以下配对方法)

将发射器和接收器放置在一米范围内,分别长按电源键开机,再长按配对按键进入配对状态。此时发射器显示灯快速交替闪烁红蓝绿光,接收器屏幕配对状态显示Pair...。配对成功后,发射器显示灯长亮蓝灯,接收器屏幕显示已连接通道状态。

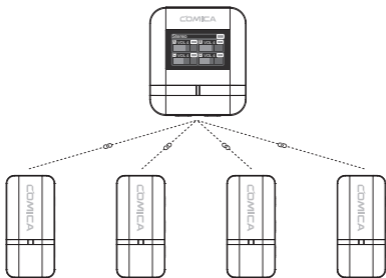

当有发射器未配对时,请将所有发射器和接收器关机,然后参照上述步骤重新进行配对。

安装方法

发射器(TX)：

根据个人需求选择使用内置/外置麦克风

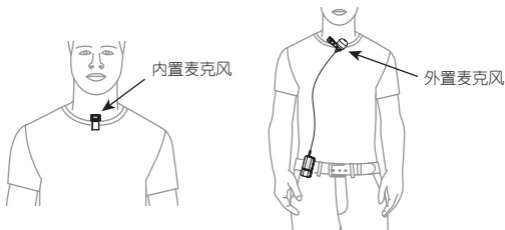

- 👉 1.当使用内置麦克风时，为了更好的隐蔽性，建议将背夹朝外固定使用
- 2.当使用外置麦克风时，内置麦克风会自动关闭

接收器 (RX) :

单声道/立体声模式

1. 模拟输出

搭配相机使用时，通过3.5mm TRS-TRS音频连接线连接即可；搭配手机或电脑使用时，通过3.5mm TRS-TRRS音频连接线和相关OTG音频转接线/转接头连接即可，可根据个人需求选择是否进行监听(请自行购买相关音频转接线/转接头)

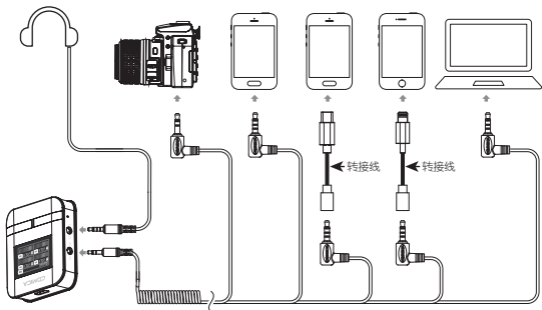

👉 在立体声模式下，A/C通道为左声道，B/D通道为右声道

2.数字输出

通过USB C-USB C/USB C-USB A音频连接线和相关OTG音频转接线/转接头连接接收器和手机/电脑，可根据个人需求选择是否进行监听(请自行购买相关音频转接线/转接头)

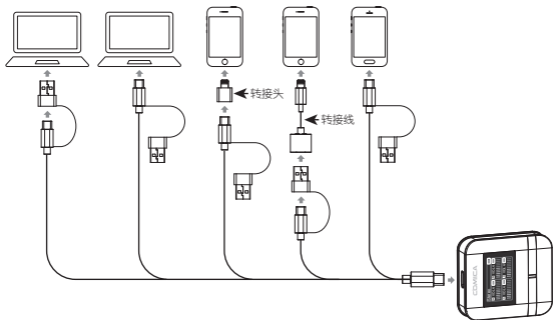

分轨模式

通过3.5mm TRS-TRS/3.5mm TRS-XLR双卡侬头音频连接线连接接收器和录音机/调音台输出A/B/C/D四路独立音轨模拟音频（请自行购买相关音频连接线）

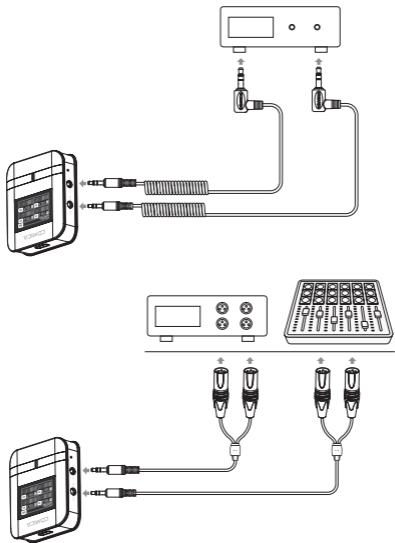

👉 通过USB输出时，不支持分轨模式

规格参数

天线类型	陶瓷天线
无线发射功率	10dBm
无线接收灵敏度	-97dBm
麦克风灵敏度	-32dB±2dB
麦克风指向性	全指向
频率响应	80Hz ~ 20kHz
系统信噪比	70dB SPL(A-weighted,as per IEC651)
系统等效噪声	24dB SPL(A-weighted,as per IEC651)
最大声压级	110dB SPL(@ 1% THD)
动态范围	86dB SPL(A-weighted,as per IEC651)
声音延迟	<20ms
USB音频规格	48kHz/24bit
电池类型	TX: 锂聚合物 140mAh 3.7V RX: 锂聚合物 600mAh 3.7V 充电盒: 锂聚合物 2900mAh 3.7V
充电时间	TX: 3小时 RX: 3小时 充电盒: 3小时
续航时间	TX: 8小时 RX: 8小时 充电盒: 1次
净重	TX: 16g RX: 37g 充电收纳盒(加配件): 330g
尺寸	TX: 51 x 24 x 21mm RX: 54 x 48 x 22mm 充电收纳盒: 186 x 93 x 63mm
工作温度	0℃ ~ 50℃
存储温度	-20℃ ~ 60℃



扫二维码关注
科唛官方公众号



COMICA科唛



COMICA科唛



COMICA科唛



COMICA科唛

邮箱: support@comica-audio.com

电话: 400-8303-981

网址: comica-audio.com

版权及科唛商标归咪莱科技有限公司所有