

**BOOMX-U**  
**QUA**

4-group Multi-functional Mini UHF Wireless Microphone

**User Manual**



## Foreword

Thanks for purchasing COMICA BoomX-U QUA Wireless Microphone

To ensure bring you a good using experience, please read this manual book carefully before using and correctly install and operate

## Main Features

- . 4-group UHF Wireless Microphone, Broadcast Level
- . 24 Channels, Support Multi-receiver Monitoring & Shooting
- . 180°Foldable Antenna, 120m Super-long Transmission Distance
- . Support 4 Audio Tracks Mixing and Individual Output
- . Support Charging While in Use, Battery Life Up to 6 Hours
- . Internal and External Two Input Modes
- . Support Auto-scanning/Manual Channel-setting
- . LCF, 16-level Adjusted Gain Control, Optional Language, Muting Functions
- . LCD Screen for Intuitive Power and Audio Dynamic Monitor
- . Special Anti-loose Design for External Lavalier Mic
- . Designed with Multi-functional Belt Clip and Compact

## Notice

- ⚠ Please make sure the IR sensor are closely aligned when pairing
- ⚠ Do not block the antenna position to avoid any poor signal generated
- ⚠ It is recommended to open and adjust the antenna of transmitter and receiver to appropriate angle for stable transmission and long working distance
- ⚠ It is recommended to unfold the antenna of receiver when using auto scan function, or it will easily cause the scan to fail
- ⚠ Please choose to close the group to save power of the receiver when there is no need for multi-group use
- ⚠ It is recommended to keep a distance more than one meter between each transmitter when using IR sync function, or it is easy to cause mismatching
- ⚠ The product belongs to high-precision instruments, please avoid falling, collision or pounding
- ⚠ Do not use the equipment in the vicinity of heat source or interference source, such as radiator, oven, refrigerator or air conditioner
- ⚠ When the pick-up distance is close or it is used outdoors, please put on the wind muff to prevent sound burst or reduce wind noise
- ⚠ Do not use the equipment in rain or in a damp environment to avoid short-circuit danger
- ⚠ Please keep the product in a dry environment

## Packing List

Main Parts:

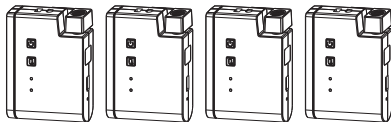

Transmitter (TX)

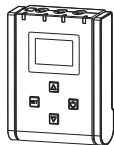

Receiver (RX)

## Accessories:

- ① 3.5mm Mic Audio Input Cable
- ② Wind Muff
- ③ 3.5mm TRS-XLR Audio Cable
- ④ 3.5mm TRS-TRS Audio Cable
- ⑤ 3.5mm TRS-TTRS Audio Cable
- ⑥ 3 in 1 Charging Cable
- ⑦ Cold-shoe Quick Release Plate
- ⑧ Carry Case
- ⑨ User Manual
- ⑩ Warranty Card



①x4



②x4



③



④



⑤



⑥



⑦



⑧



⑨



⑩

## Components and Instruction

### Transmitter(TX):

1. Power/Low Cut Filter Button
2. Muting Button
3. Power/Low Cut Filter Indicator Light
4. Audio Status Indicator Light
5. External Mic Locking Buckle
6. 3.5mm TRS Port of External Mic
7. Internal Mic
8. IR Sensor
9. USB-C Charging Port
10. Reset Hole
11. Belt Clip
12. Antenna

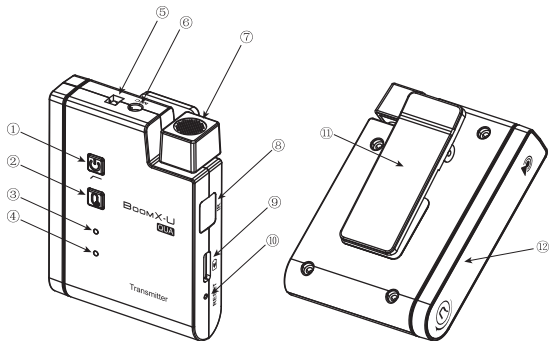

## Receiver(RX):

1. Group B Antenna
2. Group A/B/C/D Working Status Indicator
3. Display Screen
4. Menu Function Button+
5. Function Setting Button
6. Power/Menu Back Button
7. Menu Function Button-
8. IR Sensor
9. 3.5mm TRS/TRRS Monitoring Port
10. 3.5mm TRS Audio Output Port(Group C/D&MIX Output Mode)
11. 3.5mm TRS Audio Output Port(Group A/B&MIX Output Mode)
12. Group A Antenna
13. Belt Clip
14. USB-C Charging Port
15. Reset Hole

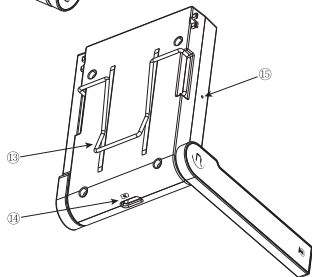
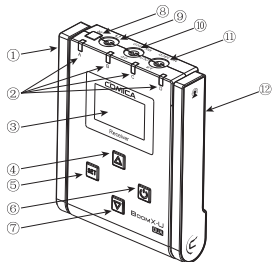

## Screen Display and Function Introduction

### Transmitter (TX)

#### Function Introduction:

##### 1. Power/Low Cut Filter Button

Long press for On/Off; Short press for Low Cut Filter



##### 2. Muting Button

Long press to switch between normal recording and mute



##### 3. Power /Low Cut Filter Indicator Light

The blue light stays on when it is turned on; The purple light keeps on when in Low Cut Filter mode; The red light flashes during pairing or low battery and keeps on when charging



##### 4. Audio Status Indicator Light

The blue light flashes when the sound is input; the red light is on when the sound is crackled, and stays on when in the muting



##### 5. Reset Hole

If there is an abnormal phenomenon such as the device is crash or unable to turn on, insert the reset pin into the reset hole to reset it





#### 6. Internal Mic

Point the built-in microphone at the sound source to record



#### 7. 3.5mm TRS Port of External Mic

Insert 3.5mm TRS microphone input cable and use the external lavalier microphone to record. At this time, the internal microphone of the device is turned off



#### 8. IR Sensor

It's paired successfully only when the transmitter and receiver's IR sensor are closely aligned



#### 9. USB-C Charging Port

Connect the transmitter with the 5V power through the 3 in 1 charging cable to charge



## Receiver (RX)

### Screen Display:

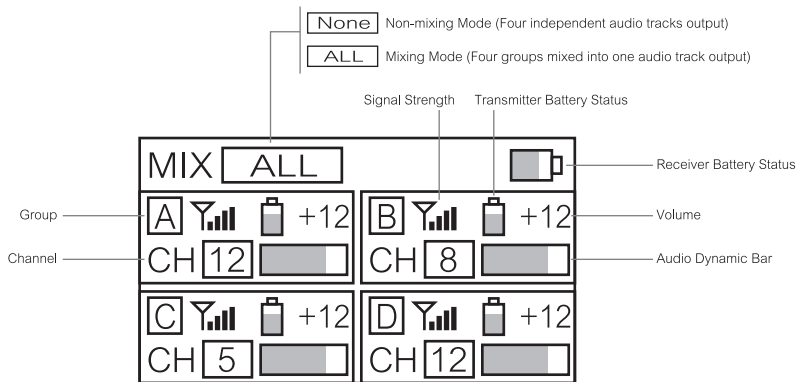

## Function Introduction:

### 1. Power/Menu Back Button

Long press for On/Off; Short press to back to the previous menu



### 2. Function Setting Button

Short press to enter the menu/confirm setting



### 3. Menu Function Button+/-

Adjust the upper and lower menus



### 4. Group A/B/C/D Working Status Indicator

The blue light keeps on when the corresponding group is successfully paired

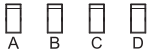

### 5. Reset Hole

If there is an abnormal phenomenon such as the device is crash or unable to turn on, insert the reset pin into the reset hole to reset it



## 6. 3.5mm TRS Audio Output Port

In the mixing mode, both ports can output one audio track mixed by four groups

In the non-mixing mode, A/B output port outputs two independent audio tracks (A and B), C/D output port outputs two independent audio tracks (C and D)

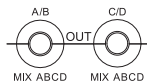

## 7. 3.5mm TRS/TRRS Monitoring Port

Plug in 3.5mm TRS/TRRS headphones to monitor; When monitoring in non-mixing mode, A/C is the left channel and B/D is the right channel



## 8. IR Sensor

It's paired successfully only when the transmitter and receiver's IR sensor are closely aligned



## 9. USB-C Charging Port

Connect the receiver with 5V power through 3 in 1 charging cable for charging



## Installation and Usage

### Pairing Method:

Choose manual/automatic pairing according to personal needs

#### A. Manual Pairing

Enter "Channel", select the corresponding channel according to personal needs; Enter "Sync", keep the IR sensor of the transmitter and receiver closely aligned, and then synchronize one by one to successfully pair

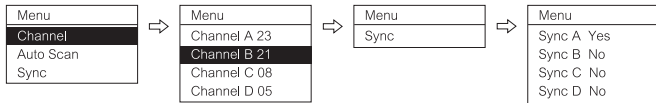

#### B. Automatic Pairing

Enter "Auto Scan", the receiver will automatically select the most suitable channel for the current environment; Enter "Sync", keep the IR sensor of the transmitter and receiver closely aligned, and then synchronize one by one to successfully pair

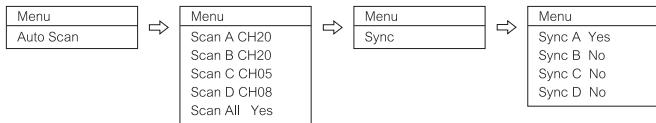

1. It is recommended to unfold the antenna of receiver when using auto scan function, or it will easily cause the scan to fail
2. In "Auto Scan", the user can choose to scan four channels one by one or scan these simultaneously
3. It is recommended to keep a distance more than one meter between each transmitter when using IR sync function, or it is easy to cause mismatching

## Installation Method:

### Transmitter (TX)

Choose internal/external mic according to personal needs

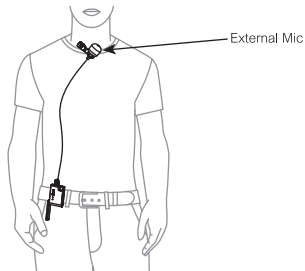
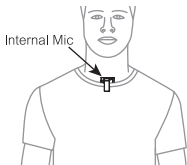

1. For better concealment during use, it is recommended that the belt clip is fixed on the outside for use
2. When the external microphone is working, the internal microphone will be automatically turned off
3. Rotate the antenna to 180° for the best signal

## Receiver (RX)

### A. Mixing Output

#### 1. Work with Camera/Camcorder/Recorder

Connect the receiver with camera/camcorder/recorder through the 3.5mm TRS-TRS/3.5mm TRS-XLR audio cable; Choose whether to monitor according to personal needs

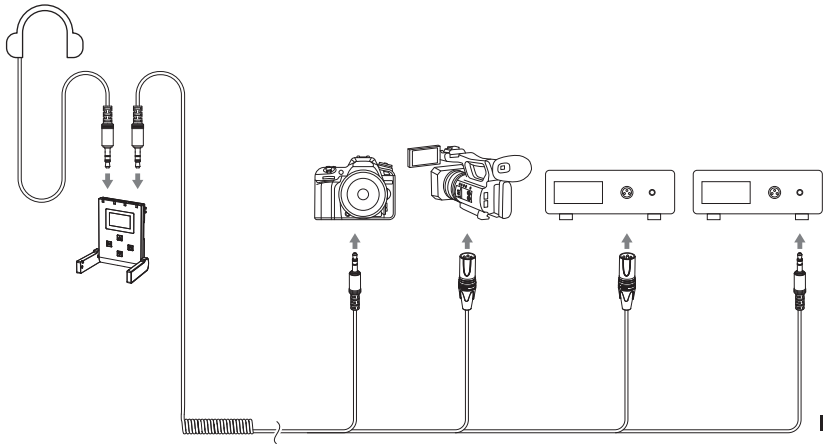

## 2. Work with Smartphone/Computer

Connect the receiver with smartphone/computer through the 3.5mm TRS-TRRS audio cable; Choose whether to monitor according to personal needs(Please purchase related audio cables/audio adapter cables by yourself)

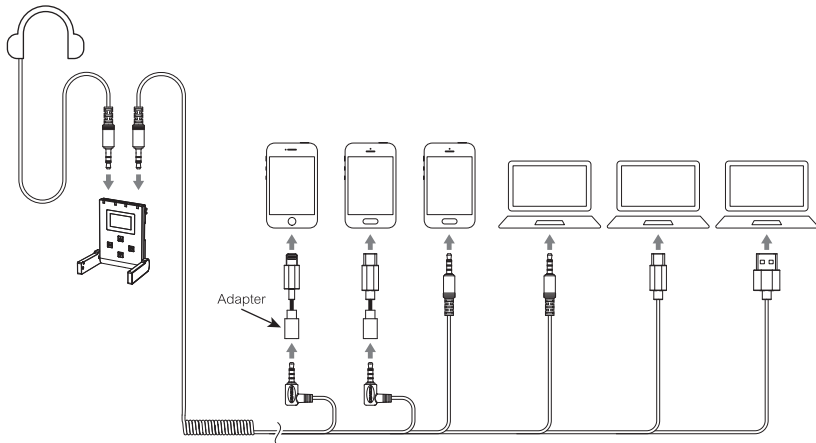



## B. Non-mixing Output

### 1. Dual-group Output: work with camera/camcorder/recorder/computer

Connect the receiver with camera/camcorder/recorder/computer through related audio cables/audio adapter cables; Choose whether to monitor according to personal needs(Please purchase related audio cables/audio adapter cables by yourself)

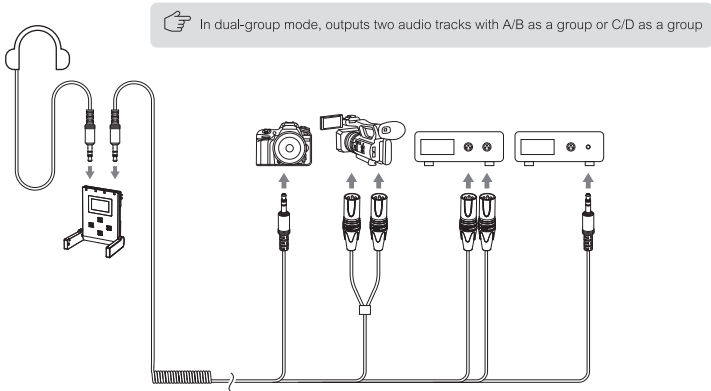

## 2. Four-group Output: work with recorder

Connect the receiver with recorder through the 3.5mm TRS-TRS/3.5mm TRS-XLR audio cable; Choose whether to monitor according to personal needs

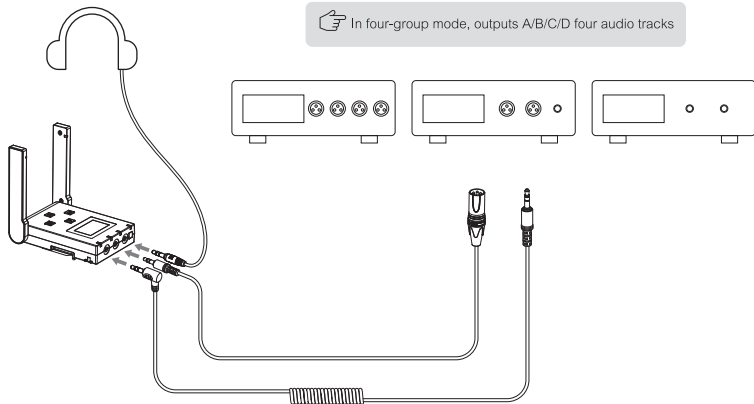

## Specifications

### Transmitter(TX)

Antenna	PCB Antenna
Polar Pattern	Omnidirectional
Frequency Response	80Hz ~ 20kHz
Maximum SPL	100dB SPL(@ 1% THD)
S/N	75dB SPL(A-weighted,as per IEC651)
Equivalent Noise	19dB SPL(A-weighted,as per IEC651)
Dynamic Range	81dB SPL(A-weighted,as per IEC651)
Sound Delay	<20ms
External Mic Input Interface	3.5mm TRS
Battery	Li-ion Battery 600mAh 3.7V
Standby Time	5 Hours
Net Weight	47g
Dimension	49 x 22 x 66mm
Operating Temperature	0 C ~ 50 C
Storage Temperature	-20 C ~ 60 C

### Receiver(RX)

Antenna	PCB Antenna
Sensitivity	-90dBm
S/N	75dB SPL(A-weighted,as per IEC651)
Equivalent Noise	19dB SPL(A-weighted,as per IEC651)
Dynamic Range	81dB SPL(A-weighted,as per IEC651)
Sound Delay	<20ms
Audio Output Interface	3.5mm TRS x 2
Monitoring Interface	3.5mm TRS/TRRS
Battery	Li-ion Battery 1400mAh 3.7V
Standby Time	6 Hours
Net Weight	85g(Not Include Cold-shoe Plate)
Dimension	65 x 16 x 82mm
Operating Temperature	0 C ~ 50 C
Storage Temperature	-20 C ~ 60 C

## Parameters

### Transmitter(TX)

Channels	24 x 4
Group A Wireless Frequency Bands	568.125MHz ~ 573.875MHz
Group B Wireless Frequency Bands	580.125MHz ~ 585.875MHz
Group C Wireless Frequency Bands	574.125MHz ~ 579.875MHz
Group D Wireless Frequency Bands	586.125MHz ~ 591.875MHz
Transmitting Power	15dBm

### Receiver(RX)

Channels	24 x 4
Group A Wireless Frequency Bands	568.125MHz ~ 573.875MHz
Group B Wireless Frequency Bands	580.125MHz ~ 585.875MHz
Group C Wireless Frequency Bands	574.125MHz ~ 579.875MHz
Group D Wireless Frequency Bands	586.125MHz ~ 591.875MHz





Website: [comica-audio.com](http://comica-audio.com)

Facebook: Comica Audio Tech Global

Instagram: Comica Audio

YouTube: Comica Audio

The COMICA LOGO is a trademark which is registered and owned by Commlite Technology Co.,Ltd

Email: [support@comica-audio.com](mailto:support@comica-audio.com)

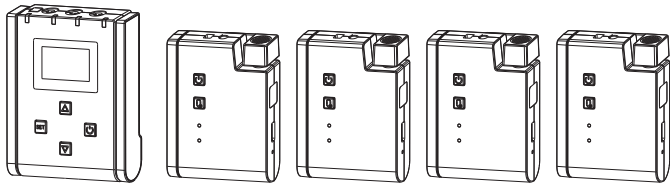

BOOMX-U  
QUA

四通道多功能迷你UHF无线麦克风

用户使用手册





## 前言

感谢您购买COMICA/科凌BoomX-U QUA无线麦克风  
为保证产品的顺畅使用，请在使用前严格阅读本说明书，并正确组装及操作

## 产品主要功能

- 四通道UHF无线麦克风，广电级音质
- 24个频道，支持多接收监听，多机位拍摄
- 180°可折叠天线，120米超长传输距离
- 支持四路音频声道并轨/分轨输出
- 支持USB-C充电口边充边用，续航长达6小时
- 内置和外置MIC两种输入方式
- 支持自动扫描/手动调频配对
- 低切，16级增益，多语言选择及静音等其他功能
- 可视化电量及音频动态显示条
- 特殊的MIC防松设计
- 多功能背夹设计，小巧精悍

## 注意事项

- ⚠ 请注意配对时发射器与接收器的红外对码窗相对才能进行有效配对
- ⚠ 使用时避免任何物体遮挡天线位置，以免信号不良
- ⚠ 为确保稳定、远距离信号传输效果，使用时请打开天线并调整至最佳角度
- ⚠ 使用自动扫描功能时，需打开接收器的天线，否则容易导致扫描失败
- ⚠ 当无多通道使用需求时，可选择性关闭通道，节省接收器的电量
- ⚠ 对码时，建议每个发射器之间保持一米以上的距离，否则容易造成误对码
- ⚠ 本产品属于高精密度仪器类产品，请避免使用时掉落、碰撞或重击
- ⚠ 请勿将本设备放置在热源或干扰源附近使用，如散热器、烤箱、冰箱、空调等
- ⚠ 如拾音距离较近或于户外使用时，请套上麦克风防风毛，防止声音爆裂或降低风噪
- ⚠ 不要在雨中或潮湿的环境中使用该设备，否则会有短路的危险
- ⚠ 请在干燥环境中对该产品进行保存

## 包装清单

主体:

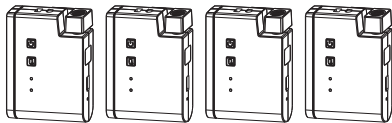

发射器 (TX)

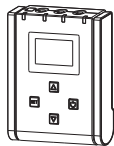

接收器 (RX)

## 配件：

- ① 3.5mm 麦克风输入线
- ② 防风毛
- ③ 3.5mm TRS-XLR音频连接线
- ④ 3.5mm TRS-TRS音频连接线
- ⑤ 3.5mm TRS-TRRS音频连接线
- ⑥ 三合一充电线
- ⑦ 冷靴快装板
- ⑧ 便携包
- ⑨ 说明书
- ⑩ 保修卡



①x4



②x4



③



④



⑤



⑥



⑦



⑧



⑨



⑩

## 部件介绍及说明

### 发射器：

1. 电源/低切按键
2. 静音按键
3. 电源/低切指示灯
4. 音频状态指示灯
5. 外置麦克风插头卡扣
6. 3.5mm TRS外置麦克风插孔
7. 内置麦克风
8. 红外对码窗
9. USB-C充电插口
10. 复位孔
11. 背夹
12. 天线

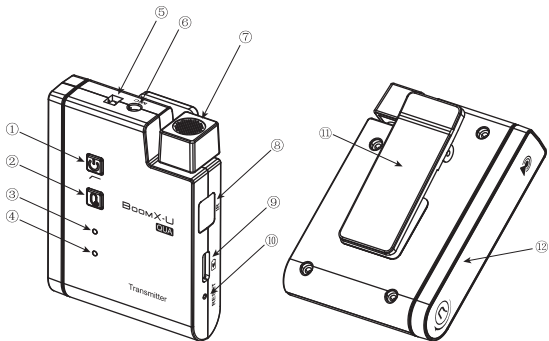

## 接收器:

1. B通道天线
2. A/B/C/D通道工作状态指示灯
3. 显示屏
4. 功能调节按键+
5. SET功能菜单按键
6. 电源/菜单返回按键
7. 功能调节按键-
8. 红外对码窗
9. 3.5mm TRS/TRRS耳机监听插孔
10. 3.5mm TRS音频输出插孔 (C/D通道&MIX模式输出)
11. 3.5mm TRS音频输出插孔 (A/B通道&MIX模式输出)
12. A通道天线
13. 背夹
14. USB-C充电插口
15. 复位孔

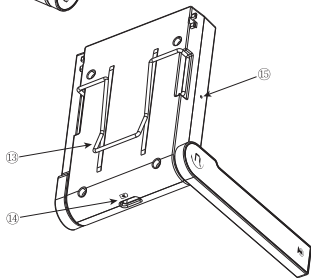
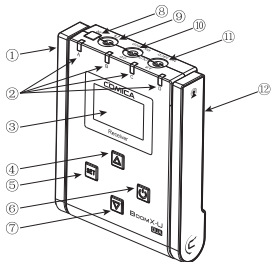

## 屏幕显示与功能介绍

### 发射器 (TX)

#### 按键功能介绍:

##### 1. 电源/低切按键

长按开机/关机；短按切换低切



##### 2. 静音按键

长按正常录音与静音切换



##### 3. 电源/低切指示灯

开机后蓝灯常亮；低切模式下紫灯长亮；与接收器配对进行时红灯闪烁；低电时红灯闪烁；充电时红灯长亮



##### 4. 音频状态指示灯

声音输入时蓝灯闪烁；声音过爆时红灯亮；静音状态下红灯长亮



##### 5. 复位孔

如出现死机/无法开机等异常现象，使用复位针插入复位孔即可重置



6. 内置麦克风

将内置麦克风对准音源即可录音



7. 3.5mm TRS外置麦克风插孔

插入3.5mm TRS麦克风输入线，即可使用外置领夹麦克风进行录音，此时本机的内置麦克风自动关闭



8. 红外对码窗

配对时发射器与接收器的红外对码窗需相对才能配对成功



9. USB-C充电插口

通过三合一充电线连接发射器与5V电源进行充电



## 接收器 (RX)

屏幕显示:

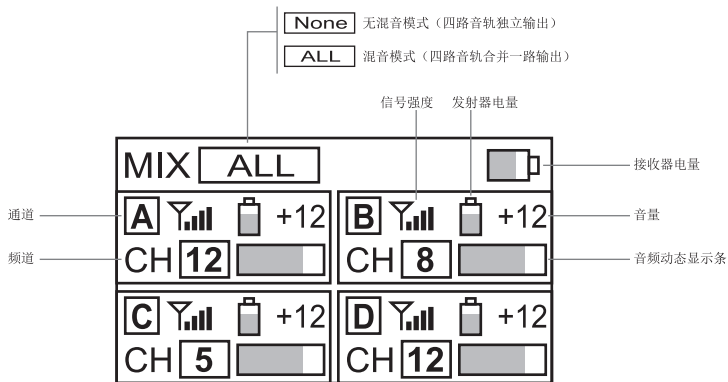



## 按键功能介绍:

### 1. 电源/菜单返回按键

长按开机/关机; 短按返回上一级菜单



### 2. SET功能菜单按键

短按进入菜单栏/确认操作



### 3. 功能调节按键+/-

在菜单栏中进行上下级菜单调节操作



### 4. A/B/C/D通道工作状态指示灯

对应通道配对成功时蓝灯长亮

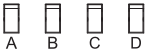

### 5. 复位孔

如出现死机/无法开机等异常现象, 使用复位针插入复位孔即可重置



### 6. 3.5mm TRS音频输出插孔

混音模式下，两个插口均可输出四路通道合并的音轨

无混音模式下，A/B输出A和B两路独立音轨，C/D输出C和D两路独立音轨

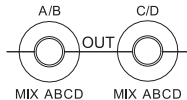

### 7. 3.5mm TRS/TRRS耳机监听插孔

插入3.5mm TRS/TRRS耳机即可监听；无混音模式下监听时，AC为左声道，BD为右声道



### 8. 红外对码窗

配对时发射器与接收器的红外对码窗需相对才能配对成功



### 9. USB-C充电插口

通过三合一充电线连接接收器与5V电源进行充电



## 安装与使用方法

### 配对方法:

根据个人需求选择手动/自动配对

#### A. 手动配对

进入“频道设置”，根据个人需求选择相对应的频道；进入“同步设置”，保持发射器与接收器的红外对码窗相对，逐个进行同步，即可配对成功

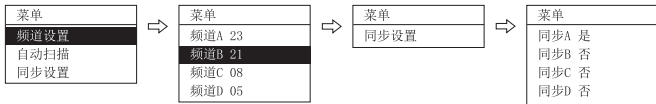

#### B. 自动配对

进入“自动扫描”，接收器自动选择最适合当下环境的频道；进入“同步设置”，保持发射器与接收器的红外对码窗相对，逐个进行同步，即可配对成功

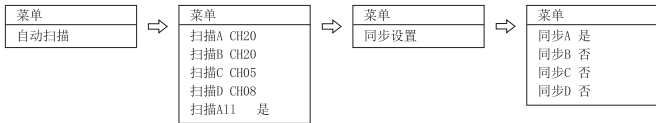

1. 使用自动扫描功能时，需打开接收器的天线，否则容易导致扫描失败
2. 自动扫描支持四个通道逐个扫描或同步扫描
3. 同步设置时，建议各发射器之间保持一米以上的距离，以免造成误对码

## 安装方法

### 发射器 (TX)

根据个人需求选择使用内置/外置麦克风

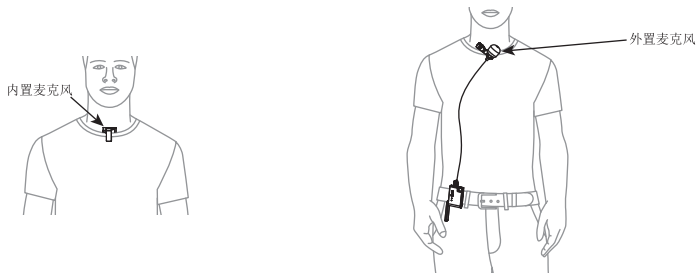

1. 在使用过程中为了更好的隐蔽性, 可将背夹朝外固定使用
2. 当使用外置麦克风时, 内置麦克风会自动关闭
3. 天线旋转180度为信号最佳状态

## 接收器 (RX)

### A. 并轨输出

#### 1. 搭配相机/摄像机/录音机

通过3.5mm TRS-TRS/3.5mm TRS-XLR音频连接线连接接收器和相机/摄像机/录音机；根据个人需求选择是否进行监听

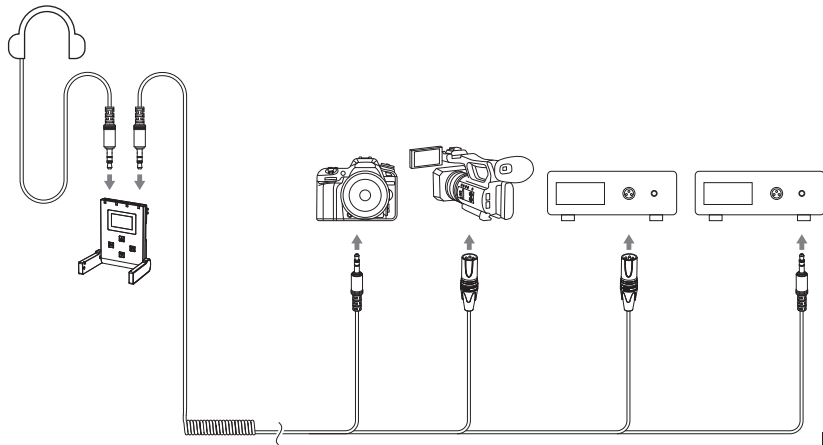

## 2. 搭配手机/电脑

通过3.5mm TRS-TRS音频连接线和相关音频转接线连接接收器和手机/电脑；根据个人需求选择是否进行监听（相关音频连接线/转接线请自行购买）

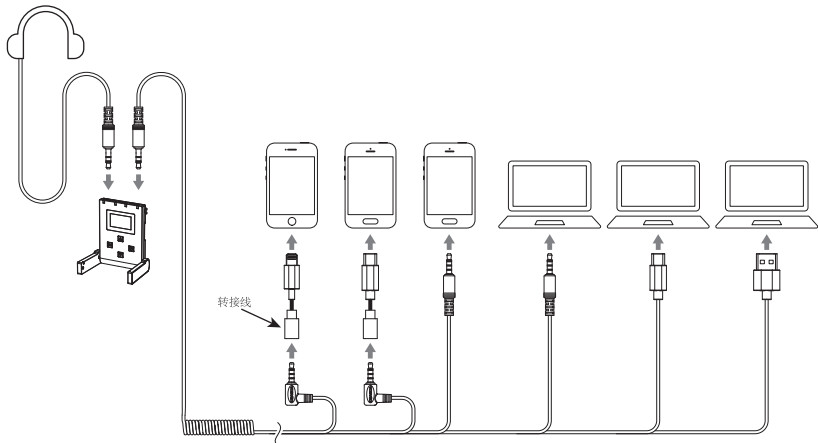

## B. 分轨输出

### 1. 双通道输出：搭配相机/摄像机/录音机/电脑

通过相关音频连接线/转接线连接接收器和相机/摄像机/录音机/电脑；根据个人需求选择是否进行监听（相关音频连接线/转接线请自行购买）

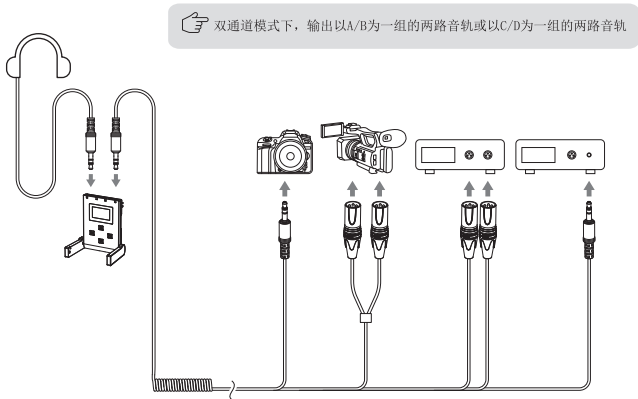

## 2. 四通道输出：搭配录音机

通过3.5mm TRS-TRS/3.5mm TRS-XLR音频连接线连接接收器和录音机；根据个人需求选择是否进行监听

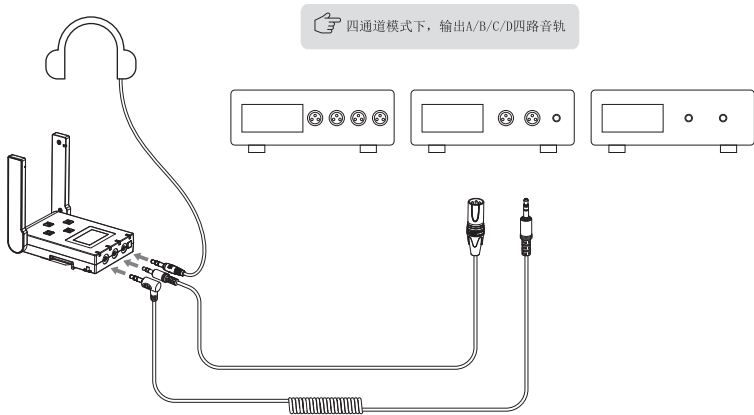



## 技术规格

### 发射器 (TX)

天线	PCB天线
麦克风指向性	全指向
麦克风频响	80Hz ~ 20kHz
最大声压级	100dB SPL(@ 1% THD)
系统信噪比	75dB SPL(A-weighted, as per IEC651)
系统等效噪声	19dB SPL(A-weighted, as per IEC651)
系统动态范围	81dB SPL(A-weighted, as per IEC651)
声音延迟	<20ms
外置输入接口	3.5mm TRS
电池	锂聚合物电池 600mAh 3.7V
续航时间	5小时
净重	47g
尺寸	49 x 22 x 66mm
工作温度	0°C ~ 50°C
存储温度	-20°C ~ 60°C

### 接收器 (RX)

天线	PCB天线
接收灵敏度	-90dBm
系统信噪比	75dB SPL(A-weighted, as per IEC651)
系统等效噪声	19dB SPL(A-weighted, as per IEC651)
系统动态范围	81dB SPL(A-weighted, as per IEC651)
声音延迟	<20ms
音频输出接口	3.5mm TRS x 2
监听接口	3.5mm TRS/TRRS
电池	锂聚合物电池 1400mAh 3.7V
续航时间	6小时
净重	85g(不包含固定座)
尺寸	65 x 16 x 82mm
工作温度	0°C ~ 50°C
存储温度	-20°C ~ 60°C

## 技术参数

### 发射器 (TX)

频道数	24 x 4
Group A 无线频段	568.125MHz ~ 573.875MHz
Group B 无线频段	580.125MHz ~ 585.875MHz
Group C 无线频段	574.125MHz ~ 579.875MHz
Group D 无线频段	586.125MHz ~ 591.875MHz
发射功率	15dBm

### 接收器 (RX)

频道数	24 x 4
Group A 无线频段	568.125MHz ~ 573.875MHz
Group B 无线频段	580.125MHz ~ 585.875MHz
Group C 无线频段	574.125MHz ~ 579.875MHz
Group D 无线频段	586.125MHz ~ 591.875MHz





扫二维码关注  
科唛官方公众号



COMICA科唛



COMICA科唛



COMICA科唛



COMICA科唛

邮箱：[support@comica-audio.com](mailto:support@comica-audio.com)

电话：400-8303-981

网址：[comica-audio.com](http://comica-audio.com)

版权及科唛商标归味莱科技有限公司所有