

Vimo C

2.4G Dual-channel Mini Wireless Microphone

User Manual

Foreword

Thanks for purchasing Comica 2.4G Dual-channel Mini Wireless Microphone Vimo C

Features

- Broadcasting-level Sound Quality, Universal for Camera, Phone and Computer
- Digital Signal Processing, Support One-key Noise Reduction
- Support Mono/Stereo/Safety Mode Switch
- 4-level Adjusted Gain Control and One-click Muting
- Rotatable IPS Display for Intuitive Operation and Usage
- Rechargeable Storage Case for Charging, Storing and Power Monitoring
- Duration Up to 20 Hours, Support Using While Charging
- USB-C Charging/Output Port for Charging and Digital Output
- Low Latency < 20ms, Working Range Up to 200m(Open Area)

Notice

- ⚠ Due to 2.4G wireless characteristics, please keep face to face when using, and don't turn your back to the receiver, otherwise it is easy to generate breakpoints, which is a normal phenomenon
- ⚠ Please pay attention that it can not realize STEREO function when in single-channel mode
- ⚠ Please do not expose the product to rain or moisture, and avoid having water or other liquids spilled on it
- ⚠ Please do not use or store the product near any heat sources such as radiators, stoves, or other heat-producing appliances
- ⚠ This product is a high-precision product, please prevent it from dropping or colliding

Packing List

Main Parts:



Transmitter(TX)



Receiver(RX)



Bat Case

Multiple Selections:



C1=TX+RX



C2=TX+TX+RX



C3=TX+TX+RX+Bat Case

Accessories:

- ① Wind Muff
- ② 3.5mm TRS-TRRS Audio Cable
- ③ 3.5mm TRS-TRS Audio Cable
- ④ 1 to 3 Charging/Output cable
(the orange cable can be used for charging and data transmitting, the black cable can only be used for charging)
- ⑤ 2 in 1 Charging/Output cable
- ⑥ User Manual
- ⑦ Warranty Card

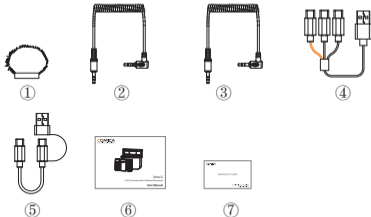

The accessories of each combination include:

C1=①+②+③+④+⑥+⑦

C2=①x2+②+③+④+⑥+⑦

C3=①x2+②+③+⑤+⑥+⑦

Components and Instruction

Transmitter (TX):

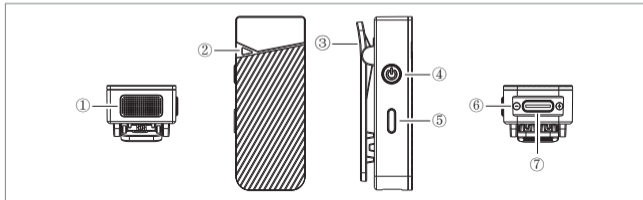

- ① Internal Mic
- ② Working Status Indicator: Blink blue when unpaired; Show blue when paired; Show green when denoise is on; Show red when muting
- ③ Belt Clip
- ④ Power/Muting Button: Long press for on/off; Short press for muting
- ⑤ Denoise/Pairing Button: Short press for denoise on/off; Long press for pairing
- ⑥ Charging Contact
- ⑦ USB-C Charging Port

Receiver (RX):

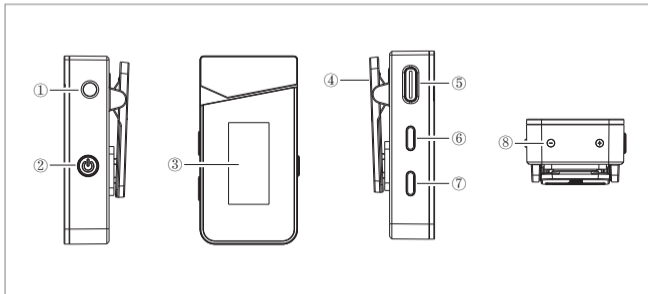

① **3.5mm TRS Audio Output Port**

② **Power/Mono/Stereo/Safety Mode Switch Button:**

Long press for On/Off; Short press for mono/stereo/safety mode switch

③ **LCD Display**

④ **Belt Clip**

⑤ **USB-C Charging/Output Port:**

For Vimo C1 and C2, connect the power bank/DC power to charge through the 1 to 3 charging/output cable, or connect with devices for digital audio output; for Vimo C3, connect the power bank/DC power to charge through the 2 in 1 charging/output cable, or connect with devices for digital audio output

⑥ **Volume Control/Pairing/Display Rotation Button:**

Short press for volume adjustment of channel A; Long press for display rotation

⑦ **Volume Control/Pairing/Display Rotation Button:**

Short press for volume adjustment of channel B; Long press for display rotation

⑧ **Charging Contact**

Bat Case:

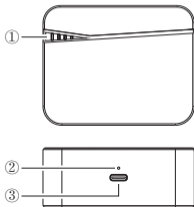

- ① **Power Indicator:** There are four power indicator lights, one of which represents 25% of the bat case's power
- ② **Reset Hole:** If there is an abnormal phenomenon such as a charging problem, insert a reset pin into the reset hole to reset it
- ③ **USB-C Charging Port**



The transmitters and receiver are automatically turned off when placed in the Bat Case and turned on automatically when removed

Screen Display

Receiver(RX):

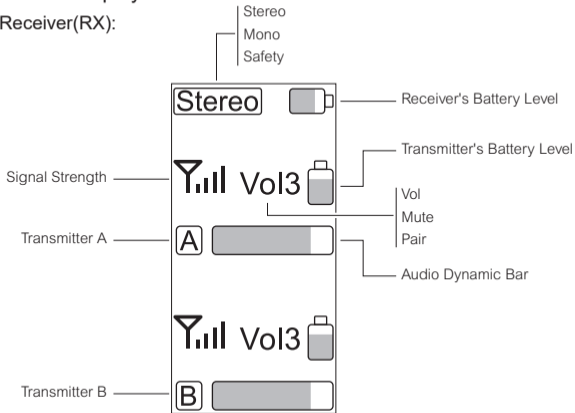

Installation and Usage

Pairing (All have been paired at the factory. If you need to re-pair, please follow the following description.)

When neither of the transmitters are paired, turn on the transmitters and receiver; Long press two pairing buttons on the receiver simultaneously until the display shows "PAIR" (If your receiver's display is dim, short press any button on it to light up the display first); Long press the pairing buttons on the two transmitters respectively until they get paired. During pairing, the indicators on the transmitters blink blue rapidly; When paired, the indicators on the transmitters show blue, and the receiver's display shows the status of the transmitters



When one of the transmitters is not paired, turn off the paired transmitter first and follow the steps above to pair the unpaired one. When it is paired, turn on the other paired transmitter to use



Usage

1. Transmitter Installation

Install the transmitter on the collar so that the internal mic points to the sound source

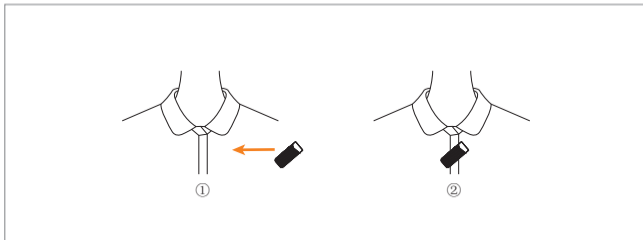

2. Output Methods for Receiver

Analog Output

Hold the receiver through the belt clip to the camera's hot shoe mount, then connect the receiver with camera through the 3.5mm TRS-TRS audio cable

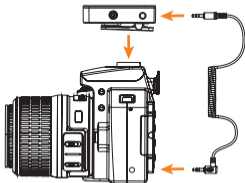

Connect the receiver and the mobile phone/computer via the 3.5mm TRS-TRRS audio cable and corresponding audio adapter cable (Please purchase audio adapter cable by yourself)

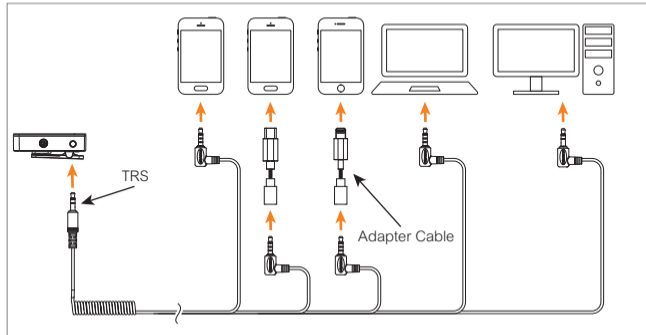

Digital Output

For Vimo C1 and C2, connect the receiver and the mobile phone/computer via the 1 to 3 charging/output cable and corresponding audio adapter cable/ adapter (Please purchase audio adapter cable/adapter by yourself)

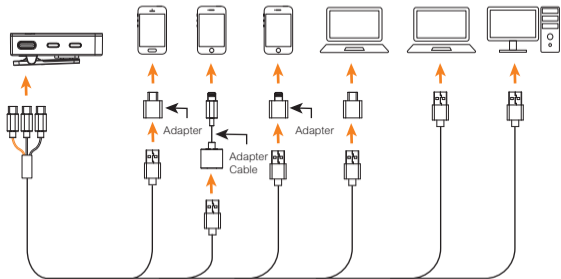

For Vimo C3, connect the receiver and the mobile phone/computer via the 2 in 1 charging/output cable and corresponding audio adapter cable/ adapter (Please purchase audio adapter cable/adapter by yourself)

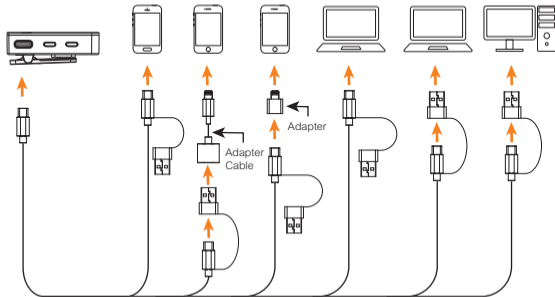

Specification

Wireless Type	2.4GHz
Antenna	Ceramic Antenna
Transmitting Power	10dBm
Sensitivity	-32dB ±2dB
Polar Pattern	Omnidirectional
Frequency Response	80Hz~20kHz
S/N	70dB
Equivalent Noise	24dBA
Maximum SPL	110dB
Dynamic Range	86dB
Sound Delay	<20ms
USB Specification	48kHz/16bit
Battery	TX: Built-in Li-ion Battery 140mAh 3.7V RX: Built-in Li-ion Battery 230mAh 3.7V Bat Case: Built-in Li-ion Battery 1400mAh 3.7V
Charging Time	TX: 2 Hours; RX: 2 Hours; Charging Case: 2 Hours
Standby Time	TX: 8 Hours; RX: 8 Hours; Bat Case: 2 times for two transmitters and one receiver charged simultaneously
Net Weight	TX: 13g; RX: 19g; Bat Case: 90g
Dimension	TX: 16x20x50mm; RX: 17x26x50mm; Bat Case: 31x63x80mm
Operating Temperature	0°C ~ 50°C
Storage Temperature	-20°C ~ 60°C



Website: comica-audio.com

Facebook: Comica Audio Tech Global

Instagram: Comica Audio

YouTube: Comica Audio

The COMICA LOGO is a trademark which is registered and owned by Commlite Technology Co.,Ltd

Email: support@comica-audio.com