

BOOMX-D PRO

2.4G Dual-channel On-board Recording Wireless Microphone

User Manual

FCC statement

This device complies with Part 15 of the FCC rules. Operation is subject to the following two conditions: 1) this device may not cause harmful interference, and 2) this device must accept any interference received, including interference that may cause undesired operation.

Note: This equipment has been tested and found to comply with the limits for a Class B digital device, pursuant to part 15 of the FCC Rules. These limits are designed to provide reasonable protection against harmful interference in a residential installation. This equipment generates uses and can radiate radio frequency energy and, if not installed and used in accordance with the instructions, may cause harmful interference to radio communications. However, there is no guarantee that interference will not occur in particular installation. If this equipment does cause harmful interference to radio or television reception, which can be determined by turning the equipment off and on, the user is encouraged to try to correct the interference by one or more of the following measures:

- Reorient or relocate the receiving antenna.
- Increase the separation between the equipment and receiver.
- Connect the equipment into an outlet on a circuit different from that to which the receiver is connected.
- Consult the dealer or an experienced radio/TV technician for help.

Changes or modifications not expressly approved by the party responsible for compliance could void the user's authority to operate the equipment.

FCC Radiation Exposure Statement

This device complies with FCC RF radiation exposure limits set forth for an uncontrolled environment. This transmitter must not be co-located or operating in conjunction with any other antenna or transmitter.

IC

This device complies with Industry Canada's licence-exempt RSSs. Operation is subject to the following two conditions:

- (1) This device may not cause interference; and
- (2) This device must accept any interference, including interference that may cause undesired operation of the device.

Le présent appareil est conforme aux CNR d'Industrie Canada applicables aux appareils radio exempts de licence. L'exploitation est autorisée aux deux conditions suivantes:

- (1) l'appareil ne doit pas produire de brouillage.
- (2) l'utilisateur de l'appareil doit accepter tout brouillage radioélectrique subi, même si le brouillage est susceptible d'en compromettre le fonctionnement.

Foreword

Thanks for purchasing COMICA BoomX-D PRO

Main Features

- . 2.4G Digital Dual-channel Wireless Microphone, Global Free Frequency
- . 48kHz/16bits Audio Recording, One-click Intelligent Denoise
- . Support On-board Recording with 8G Internal Memory(About 24 Hours)
- . Support Recording File's High-speed Transmission and Copy
- . Support Digital&Analog Output Mode, Universal for Camera/Phone/PC
- . Safety Channel for Ultimate Flexibility in Post-production
- . Visual Power, Audio Dynamic Monitor and Other Display Functions
- . M/S Switch, Real-time Audio Monitor, Mute and Volume Control
- . Internal and External MIC Two Input Modes
- . RF Technology, Auto Freq. Adjustment, Stable Transmission
- . Low Latency < 20ms, Working Range Up to 300m(Open Area)
- . Designed with Multi-functional Belt Clip and Compact

Notice

- ⚠ Due to 2.4G wireless characteristics, it's better to keep face to face when use it, and don't turn your back to the receiver, otherwise it is easy to generate breakpoints, which is a normal phenomenon
- ⚠ Don't block the antenna position to avoid any poor signal generated
- ⚠ When the transmitter and receiver are not connected, the transmitter does not show the audio dynamic bar
- ⚠ Please attention that it can not realize STEREO function when in single-channel and safety mode
- ⚠ When you need to continuously record, a new recording file will be saved every 2 hours of recording, and the total recording time is 24 hours. When the 8G memory is full, the new recording file will overwrite the old recording file
- ⚠ The recording and copy function can't be used at the same time
- ⚠ This product belongs to high-precision instruments, please avoid falling, collision or pounding
- ⚠ Do not use this equipment in the vicinity of heat source or interference source, such as radiator, oven, refrigerator or air conditioner
- ⚠ If the pick-up distance is close or when used outdoors, please put on the wind muff to prevent sound burst or reduce wind noise
- ⚠ Do not use the equipment in rain or in a damp environment to avoid short-circuit danger

Don't block the antenna position to avoid any poor signal generated

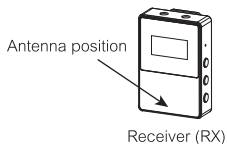
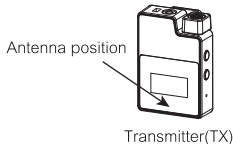

Tips

1. BoomX-D PRO is universal for USB and 3.5mm interface devices. When used in smartphone, the system will compulsorily choose BoomX-D PRO as audio input and output device
2. When used in computer, please follow the steps below:
 - ① Insert BoomX-D PRO into the computer
 - ② Click sound setting and set the "Comica_BoomX-D_PRO" as the input and output device

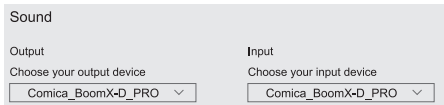

Packing List

Main Parts:

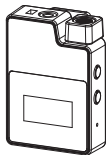

Transmitter(TX)

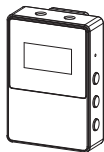

Receiver (RX)

Purchase Options:



BoomX-D PRO D1 = TX + RX
(Black/White)

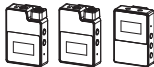

BoomX-D PRO D2 = TX + TX + RX
(Black/White)

Accessories:

- ① 3.5mm Mic Audio Input Cable
- ② Wind Muff
- ③ 3.5mm TRS-TRRS Audio Cable
- ④ 3.5mm TRS-TRS Audio Cable
- ⑤ 3 in 1 Charging/Output Cable (the orange cable can be used for charging and data transmitting, the black cable can only be used for charging)
- ⑥ Carry Case
- ⑦ User Manual
- ⑧ Warranty Card



①



②



③



④



⑤



⑥



⑦



⑧

The accessories of each combination include:

BoomX-D PRO D1= ①+②+③+④+⑤+⑥+⑦+⑧

BoomX-D PRO D2= ①x2+②x2+③+④+⑤+⑥+⑦+⑧

Transmitter (TX)

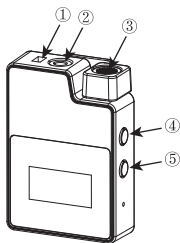

1. External Mic Locking Buckle
2. 3.5mm TRS Port of External Mic
3. Internal Mic
4. Power/Muting Button
5. Denoise/Pair Button

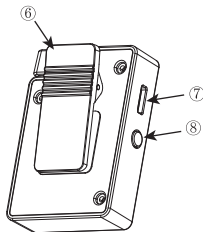

6. Belt Clip
7. USB-C Charging/Copy Port
8. REC Button

Receiver (RX)

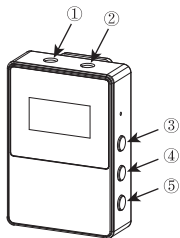

1. 3.5mm TRS/TRRS Monitoring Headphone Port
2. 3.5mm TRS Audio Output Port
3. Power/Mono/Stereo/Safety Mode Switch Button
4. A Channel Output Gain Control/Pair Button

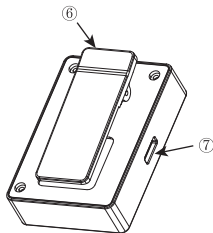

5. B Channel Output Gain Control/Pair Button
6. Belt Clip
7. USB-C Charging/Output Port

Transmitter(TX)

1.Screen Display Instruction:

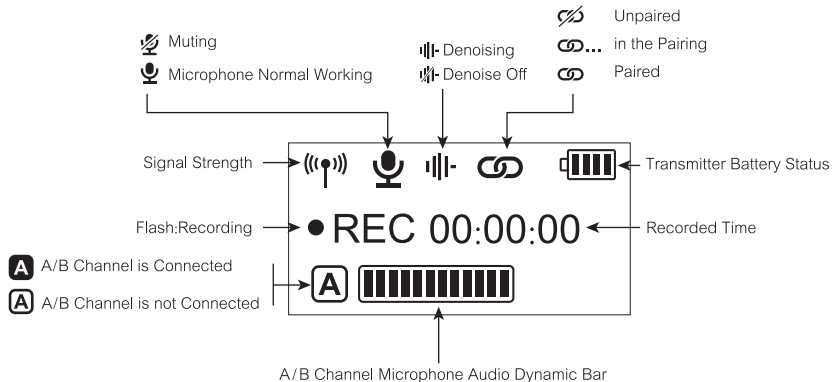

2.Function Introduction:

2.1. Muting/Power Button

Short press for muting; Long press for On/Off



2.2. Denoise/Pair Button

Short press for denoising switch; Long press for pairing with receiver



2.3. 3.5mm TRS Microphone Port

Insert the 3.5mm TRS microphone input cable, and you can use the external lavalier microphone for recording. At this time, the internal microphone of this device is turned off



2.4. USB-C Charging/Copy Port

Connect the transmitter with the power or computer through 3 in 1 charging/output cable to charge or copy recording file

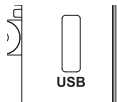

2.5. REC Button

Long press to start or stop the recording when the screen is on



- 1. All the function adjustments are only available when the screen is on, and if the screen is dimmed, press any button to light up the screen and then adjust again;
- 2. If there are abnormal phenomena such as crash or failure to turn on, please press and hold the power button for 10 seconds to reset

Receiver(RX)

1.Screen Display Instruction:

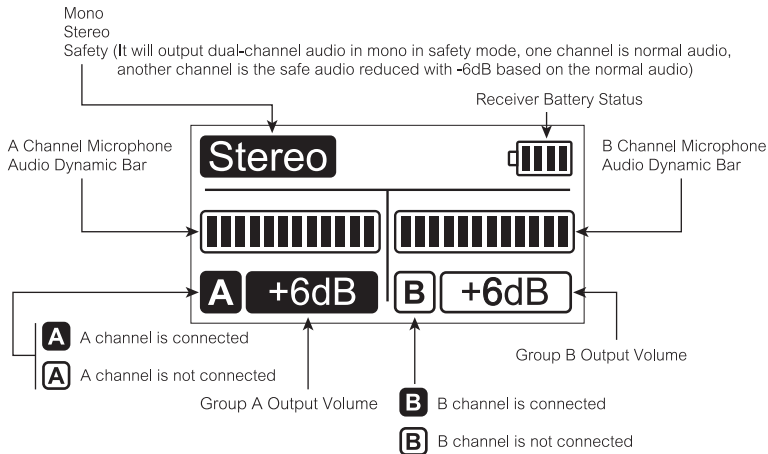

2. Function Introduction:

2.1. Power/Mono/Stereo/Safety Mode Switch Button

Long press for On/Off; Short press for mono/stereo/safety mode switch. Please attention that it can not realize STEREO function when in single-channel and safety mode



2.2. A/B Channel Output Volume Adjustment/Pair Button

Short press to cyclically adjust the A/B channel output volume. When it is not paired, long press the two buttons at the same time to pair



2.3. USB-C Charging/Output Port

Connect the receiver with the power or USB interface devices through 3 in 1 charging/output cable to charge or output

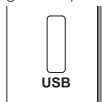

2.4. 3.5mm TRS Audio Output Port

Connect with mobile phone through the 3.5mm TRS-TRRS audio cable; Connect with camera through the 3.5mm TRS-TRS audio cable



2.5. 3.5mm TRS/TRRS Monitoring Port



Insert headphone to monitor



1. All the function adjustments are only available when the screen is on, and if the screen is dimmed, press any button to light up the screen and then adjust again;
2. If there are abnormal phenomena such as crash or failure to turn on, please press and hold the power button for 10 seconds to reset

Installation and Usage

Pairing Method (All have been paired at the factory. If you need to re-pair, please follow the description)

Turn on the transmitters and receiver within one meter; Long press the pair buttons of the transmitters and receiver to pair when the screen is on. The icon changes from  to  after pairing successfully, the first paired transmitter as channel A (left channel), and the second paired transmitter as channel B(right channel)

The screen icon changes from  to  after pairing

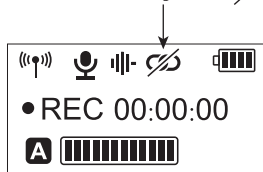

Transmitter (TX)

Transmitter(TX)

1. Use the internal/external mic according to your need

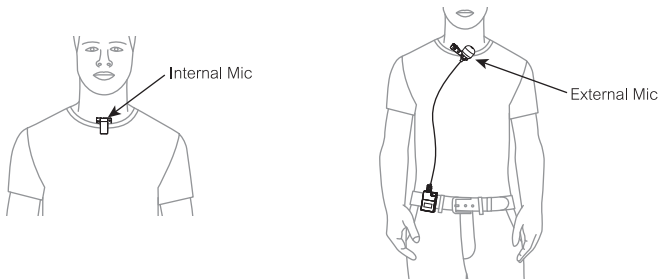

1. For better concealment during use, it is recommended that the belt clip is fixed and used outwards
2. When using an external microphone, the internal microphone is automatically turned off

2. Use the REC function according to your need

Long press to start or stop the recording when the screen is on

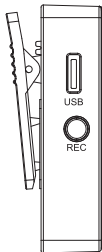

When you need to continuously record, a new recording file will be saved every 2 hours of recording, and the total recording time is 24 hours. When the 8 G memory is full, the new recording file will overwrite the old recording file

3. Copy recording file according to your need

BOOMX-D_PRO disk appears after BoomX-D PRO is connected with the computer, then you can copy the recording file

Devices and drives



Please keep the TX turned on when copying recording files

Receiver(RX)

1. Analog Output:

Work with Camera

Fix the receiver through the belt clip to the camera's hot shoe mount, then connect the receiver with camera through the 3.5mm TRS-TRS audio cable; Insert the headphone into the monitoring headphone port for monitoring

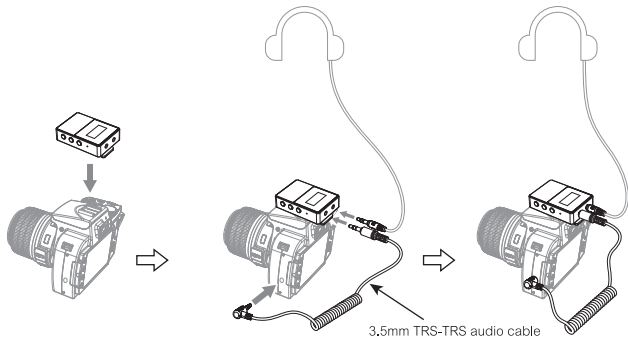

Work with Smartphone/Computer

Connect the receiver with smartphone/computer through the 3.5mm TRS-TRRS audio cable and corresponding audio adapter cable, then insert headphone to monitor according to your need (Please purchase audio adapter cable by yourself)

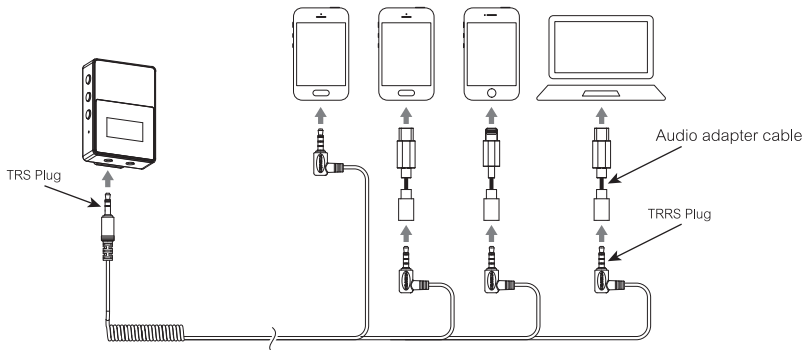

2. Digital Output:

Connect the receiver with the USB interface devices through the corresponding audio cable and audio adapter, then insert the headphone to monitor according to your need

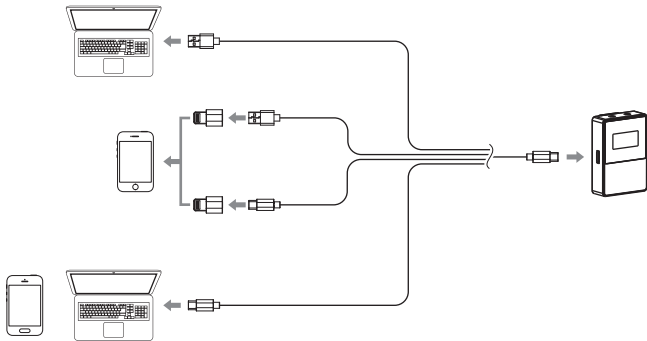

BoomX-D PRO is equipped with a USB C-USB A audio cable(the orange cable of the 3 in 1 charging/output cable) , please purchase other audio cable and audio adapter by yourself

Specifications

Transmitter (TX)

Wireless Type	2.4GHz
Antenna	Ceramic Antenna
Transmitting Power	+10dBm
Receiving Sensitivity	-32dB±2dB
Polar Pattern	Omnidirectional
Frequency Response	80Hz ~ 20kHz
S/N	70dB SPL(A-weighted,as per IEC651)
Equivalent Noise	24dB SPL(A-weighted,as per IEC651)
SPL	110dB SPL(@ 1% THD)
Dynamic Range	86dB SPL(A-weighted,as per IEC651)
Sound Delay	<20ms
External Mic Input Port	3.5mm TRS
Battery	Li-polymer 330mAh 3.7V
Standby Time	On-board Recording Mode:4.5 Hours Normal Recording Mode:15 Hours
Net Weight	29g
Dimension	39 x 22 x 55mm
Operating Temperature	0°C ~ 50°C
Storage Temperature	-20°C ~ +60°C

Receiver (RX)

Wireless Type	2.4GHz
Antenna	Ceramic Antenna
Transmitting Power	+10dBm
S/N	70dB SPL(A-weighted,as per IEC651)
Equivalent Noise	24dB SPL(A-weighted,as per IEC651)
Dynamic Range	86dB SPL(A-weighted,as per IEC651)
Sound Delay	<20ms
Volume Adjustment	-6dB ~ +6dB
Analog Output	3.5mm TRS
Digital Output	USB-C / 48kHz 16bits
Monitoring Port	3.5mm TRS/TRRS
Battery	Li-polymer 330mAh 3.7V
Standby Time	12 Hours
Net Weight	28g
Dimension	39 x 22 x 55mm
Operating Temperature	0 C ~ 50 C
Storage Temperature	-20 C ~ +60 C



Website: comica-audio.com

Facebook: Comica Audio Tech Global

Instagram: Comica Audio

YouTube: Comica Audio

The COMICA LOGO is a trademark which is registered and owned by Commlite Technology Co.,Ltd
Email: support@comica-audio.com

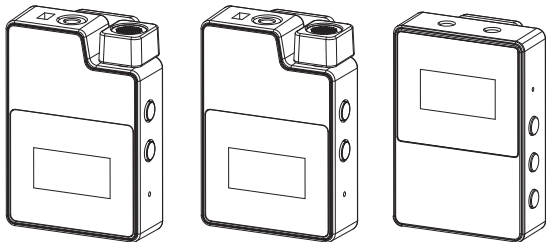

BOOMX-D PRO

2.4G 双通道板载录音无线麦克风

用户使用手册

前言

感谢您购买科唛BoomX-D PRO

产品主要功能

- . 2.4G数字双通道无线麦克风，全球通用频段
- . 48kHz/16bits录音，一键智能降噪
- . 支持8G内存板载录音及高速传输拷贝(约24小时)
- . 数字&模拟双模式输出，通用于相机，手机，电脑
- . 安全音轨模式，便于后期剪辑
- . 可视化电量，音频动态监控等屏显功能
- . 支持单声道/立体声输出，实时监听，静音及音量调节
- . 内置和外置MIC两种输入方式
- . 自动调频，传输稳定
- . 低音频延迟< 20ms，传输距离稳定高达300m
- . 多功能背夹，小巧精悍

注意事项

- ⚠ 由于2.4G无线特性，使用时尽量保持面对面，避免背对的情况，否则容易产生断点，属正常现象
- ⚠ 使用时避免任何物体遮挡天线位置，以免信号不良
- ⚠ 发射器和接收器未连接时，发射器无法显示音频动态条
- ⚠ 单通道以及安全音轨模式下，立体声（STEREO）功能不可实现
- ⚠ 当持续录音时，每录满2小时会新存为一个录音文件，总录音时长为24小时，当8G内存录满时，新录音文件会覆盖旧录音文件
- ⚠ 录音功能和拷贝功能不可同时使用
- ⚠ 本产品属于高精密仪器类产品，请避免使用时掉落、碰撞或重击
- ⚠ 请勿将本设备放置在热源或干扰源附近使用，如散热器、烤箱等
- ⚠ 如拾音距离较近或于户外使用时，请套上麦克风防风毛，防止声音爆裂或降低风噪
- ⚠ 不要在雨中或潮湿的环境中使用该设备，否则会有短路的危险

使用时避免任何物体遮挡天线位置，以免信号不良

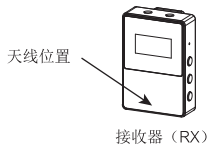
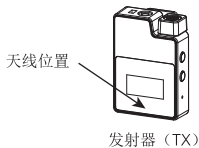

提示

1. BoomX-D PRO通用于USB和3.5mm接口的设备。当用于手机时，系统会强制性使用BoomX-D PRO
2. 当用于电脑时，请按以下步骤进行操作：
 - ① 将BoomX-D PRO插入电脑
 - ② 打开声音设置界面，选择“Comica_BoomX-D_PRO”为输出和输入设备



包装清单

主体:

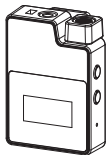

发射器 (TX)

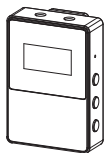

接收器 (RX)

搭配选择:



BoomX-D PRO D1 = TX + RX
(黑色/白色)

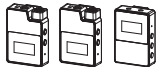

BoomX-D PRO D2 = TX + TX + RX
(黑色/白色)

配件:

- ① 3.5mm 麦克风输入线
- ② 防风毛
- ③ 3.5mm TRS-TRRS音频连接线
- ④ 3.5mm TRS-TRS音频连接线
- ⑤ 三合一充电/输出线（其中橙色线具备充电和数据传输功能，另外两条黑色线只具备充电功能）
- ⑥ 便携包
- ⑦ 说明书
- ⑧ 保修卡



④



⑤



⑥



⑦



⑧

每一个型号的配件包括:

BoomX-D PRO D1= ①+②+③+④+⑤+⑥+⑦+⑧

BoomX-D PRO D2= ①x2+②x2+③+④+⑤+⑥+⑦+⑧

发射器 (TX)

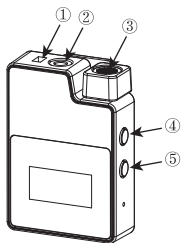

1. 外置麦克风插头卡扣
2. 3.5mm TRS外置麦克风插孔
3. 内置麦克风
4. 电源/静音按钮
5. 降噪/配对按钮

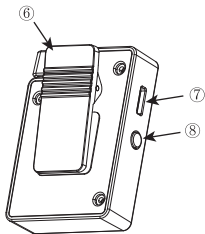

6. 背夹
7. USB-C充电/拷贝插口
8. 录音按钮

接收器 (RX)

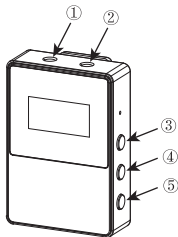

1. 3.5mm TRS/TRRS耳机监听插孔
2. 3.5mm TRS音频输出插孔
3. 电源/单声道/立体声/安全音轨切换按钮
4. A通道输出音量调节/配对按钮

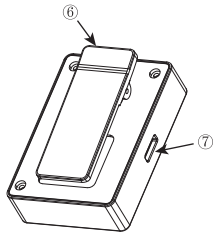

5. B通道输出音量调节/配对按钮
6. 背夹
7. USB-C充电/输出插口

发射器 (TX)

1. 屏幕显示:

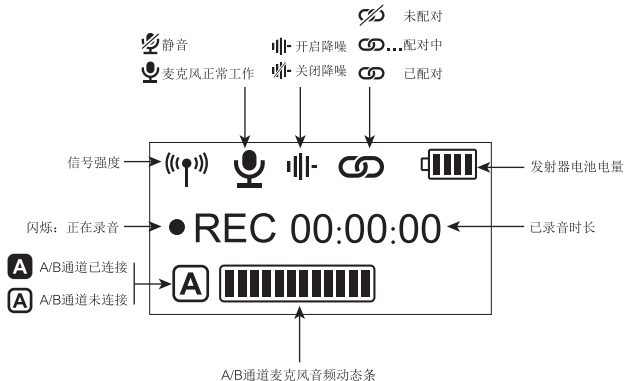

2.功能介绍:

2.1. 静音/电源按钮

短按进行静音切换，长按开机/关机



2.2. 降噪/配对按钮

短按进行降噪切换，长按与接收器进行配对



2.3. 3.5mm TRS麦克风插孔

插入3.5mm TRS麦克风输入线，即可使用外置领夹麦克风进行录音，此时本机的内置麦克风被关闭



2.4. USB-C充电/拷贝插口

使用三合一充电/输出线连接发射器可充电和拷贝录音文件

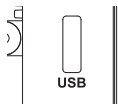

2.5. 录音按钮

在屏幕亮显的情况下长按进行录音或者停止录音



1. 所有功能调节需在屏幕亮显时才可用，如果屏幕暗显，请先按任何按键使屏幕亮显再操作；
2. 如出现死机或无法开机等异常现象，请长按开机键10秒进行复位

接收器 (RX)

1. 屏幕显示:

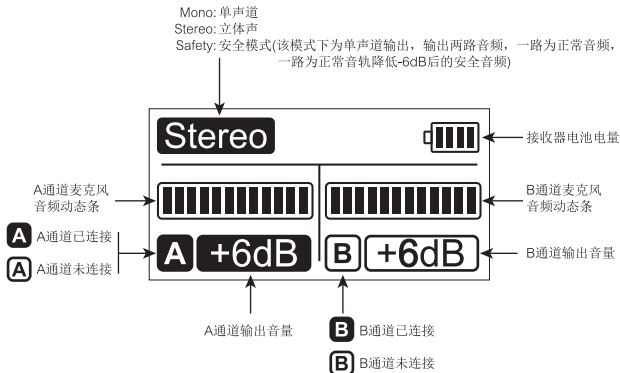

2.功能介绍:

2.1. 电源/单声道/立体声/安全音轨切换按钮

长按开机/关机，短按进行单声道、立体声与安全模式切换。单通道以及安全音轨模式下，立体声（STEREO）功能不可实现



2.2. A/B通道输出音量调节/配对按键

短按可循环调节A/B通道输出音量；未配对时，同时长按A/B按键进入配对状态



2.3. USB-C充电/输出插口

通过三合一充电/输出线连接接收器可充电或数字输出到USB接口的设备

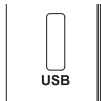

2.4. 3.5mm TRS音频输出插孔

通过3.5mm TRS-TRRS音频连接线与手机进行连接；通过3.5mm TRS-TRS音频连接线与相机进行连接





2.5. 3.5mm TRS/TRRS耳机监听插孔

插入3.5mm TRS/TRRS耳机即可监听



- 1. 所有功能调节需在屏幕亮显时才可用，如果屏幕暗显，请先按任何按键使屏幕亮显再操作；
- 2. 如出现死机或无法开机等异常现象，请长按开机键10秒进行复位

配对方法（出厂时默认配对，如需重新配对，请根据以下说明操作）

将发射器和接收器放置在一米范围内，长按电源键开机，在屏幕亮屏的情况下，再分别长按配对按键进入配对状态。配对成功后屏幕图标由  变成 ，先配对成功的发射器为A通道（左声道），后配对成功的发射器为B通道（右声道）

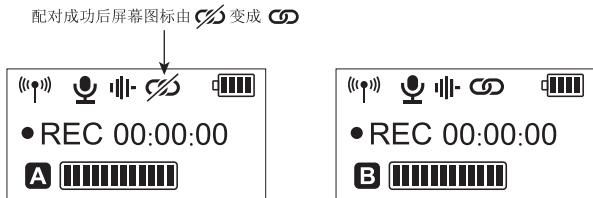

发射器（TX）

发射器 (TX)

1. 根据个人需求选择使用内置/外置麦克风

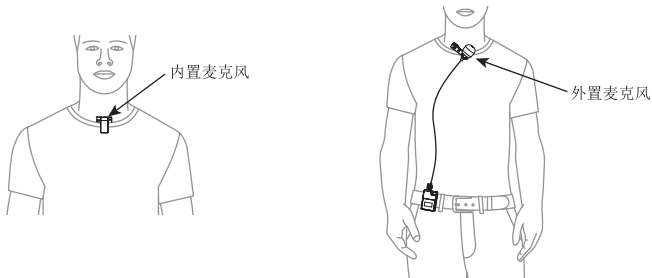

1. 在使用内置麦克风时，为了更好的隐蔽性，建议将背夹朝外固定使用
2. 当使用外置麦克风时，内置麦克风会自动关闭

2. 根据个人需求选择是否开启录音功能

在屏幕亮显的情况下长按REC进行录音或停止录音

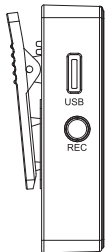

👉 持续录音时，每录满2小时会新存为一个录音文件，总录音时长为24小时，当 8G内存录满时，新录音文件会覆盖旧录音文件

3. 根据个人需求选择是否拷贝录音文件

通过TX的USB-C接口连接电脑后出现一个盘符BOOMX-D_PRO，录制的音频文件可从盘符中拷出

🔸 有可移动存储的设备 (1)



👉 拷贝录音文件时，TX需保持开机状态，否则将无法拷贝

接收器 (RX)

1. 模拟输出:

搭配相机

把接收器通过背夹夹到相机的热靴座固定；通过3.5mm TRS-TRS音频连接线连接接收器和相机；把耳机插入耳机监听插孔进行监听

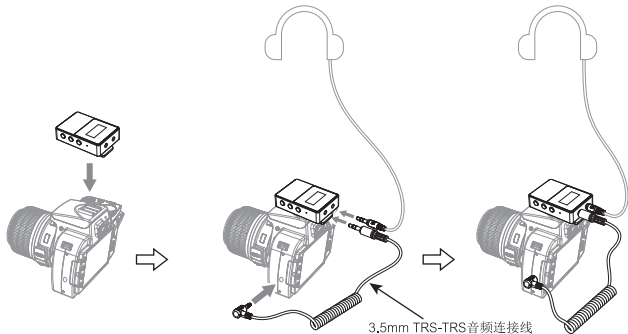

搭配手机/电脑

通过3.5mm TRS-TRRS音频连接线和相关音频转接线连接接收器和手机/电脑，可根据个人需求选择是否进行监听（转接线请自行购买）

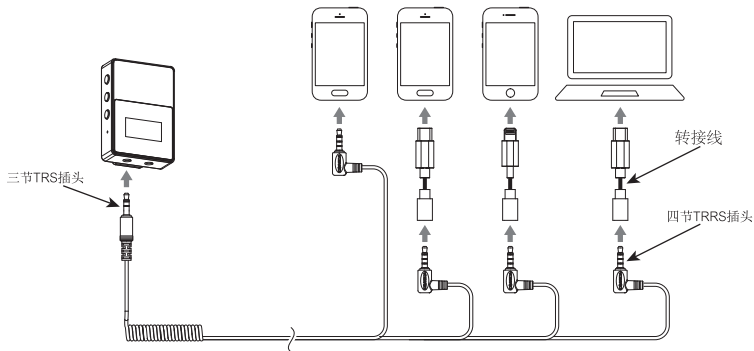

2. 数字输出:

通过相关音频连接线及转接头连接接收器和USB接口的设备，根据个人需求选择是否进行监听

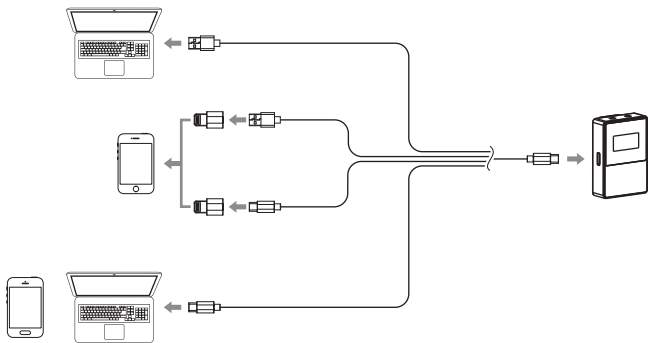

👉 USB C-USB A音频连接线可用三合一充电/输出线中的橙色线，其他音频连接线及转接头需自行购买

技术规格

发射器 (TX)

无线类型	2.4GHz
天线	陶瓷天线
发射功率	+10dBm
麦克风灵敏度	-32dB±2dB
麦克风指向性	全指向
麦克风频率响应	80Hz ~ 20kHz
系统信噪比	70dB SPL(A-weighted,as per IEC651)
系统等效噪声	24dB SPL(A-weighted,as per IEC651)
最大声压级	110dB SPL(@ 1% THD)
动态范围	86dB SPL(A-weighted,as per IEC651)
声音延迟	<20ms
外置输入接口	3.5mm TRS
电池	锂聚合物 330mAh 3.7V
续航时间	开内录4.5小时，关内录15小时
净重	29g
尺寸	39 x 22 x 55mm
工作温度	0°C ~ 50°C
存储温度	-20°C ~ +60°C

接收器 (RX)

无线类型	2.4GHz
天线	陶瓷天线
发射功率	+10dBm
系统信噪比	70dB SPL(A-weighted,as per IEC651)
系统等效噪声	24dB SPL(A-weighted,as per IEC651)
动态范围	86dB SPL(A-weighted,as per IEC651)
声音延迟	<20ms
输出调节范围	-6dB ~ +6dB
模拟输出	3.5mm TRS
数字输出	USB-C / 48kHz 16bits
监听接口	3.5mm TRS/TRRS
电池	锂聚合物 330mAh 3.7V
续航时间	12小时
净重	28g
尺寸	39 x 22 x 55mm
工作温度	0 C ~ 50 C
存储温度	-20 C ~ +60 C



扫二维码关注
科唛官方公众号



COMICA科唛



COMICA科唛



COMICA科唛



COMICA科唛

邮箱: support@comica-audio.com

电话: 400-8303-981

网址: comica-audio.com

版权及科唛商标归味莱科技有限公司所有